



JUNE 2026

PRODUCTION PROFILE

www.pruszynski.com.pl

ROOF TILES



See our assembly video instruction of MODUS, LOARA, TIGRA PLUS, FIORD and REN Rooftiles:



The modern panel roof tile **TIGRA PLUS** is a unique one due to its uncommon shape which is obtained due to repeated embossments. Trapezoidal separators standing between flat surfaces are the first aspects to catch the viewer's eye. Due to this, a characteristic pattern of „chocolate bars” is created on the roof. This type of placement causes perception of harmony and order of the roof. Additionally, surface of TIGRA PLUS tile is in fact 'nanowave-shaped.'

TIGRA PLUS



effective area	0,803 m ²
module length	350 mm
profile height	11,5 mm
fold height	30 mm
total width	1186 mm
effective width	1147 mm
min. roof slope	20°
coatings	PS, ULTRAMAT, TOPMAT, PURLAK, PURMAT
accessories	screws, seals, sealing collars, flashings, touch-up paint

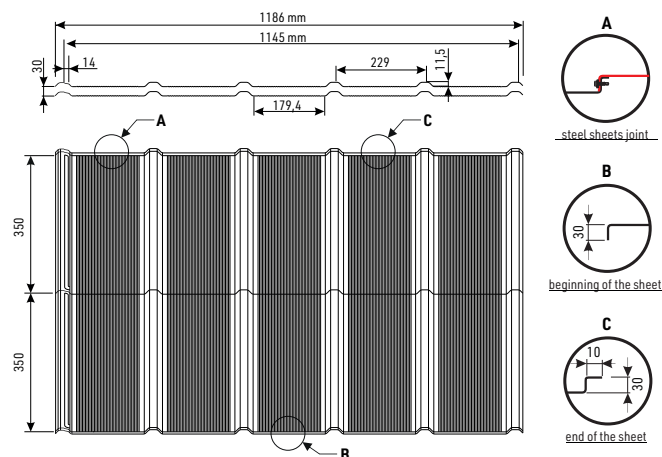

ROOF TILES



FIORD panel roof tile is a novelty in our company's offer. Expressive design attracts with firm embossment resembling on Scandinavian designing. The small embossings on the flat area improve stiffness of the panel which helps avoiding unaesthetic corrugation of the steel. They also facilitate communication on the roof not affecting the danger of possible deformation.

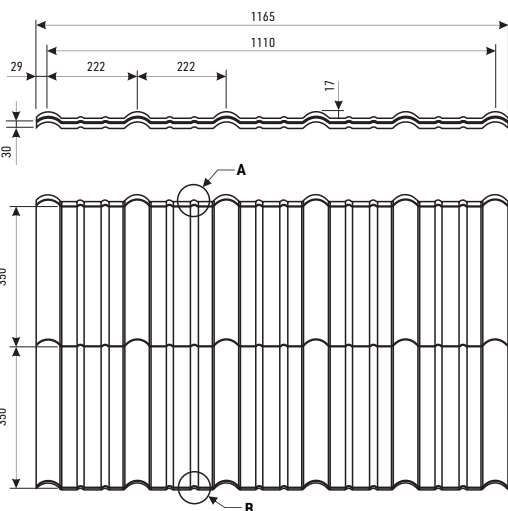

steel sheets joint



end of the sheet



beginning of the sheet

effective area	0,777 m ²
module length	350 mm
profile height	17 mm
fold height	30 mm
total width	1165 mm
effective width	1110 mm
min. roof slope	20°
coatings	PS, ULTRAMAT, TOPMAT, PURLAK, PURMAT
accessories	screws, seals, sealing collars, flashings, touch-up paint



FIORD panel roof tile has been awarded with **TOP BUILDER 2021**



FIORD panel roof tile has been awarded with **European Medal 2021**

ROOF TILES



The 'FLAT PLUS' steel roof tile is a response to the constantly growing minimalist trend. We have modified the 'FLAT' roof tile by removing the delicate embossing on the panel surface. As a result, we obtained a perfectly flat surface, which is now so often sought after by investors. Created with modern construction in mind, it brings an unobtrusive drawing on the roof. The best visual effect is reached in matt coatings.



effective area	0,387 m ²
module length	320 mm
fold height	35 mm
total width	1245 mm
effective width	1210 mm
min. roof slope	25°
coatings	PURMAT
accessories	screws, seals, sealing collars, flashings, touch-up paint

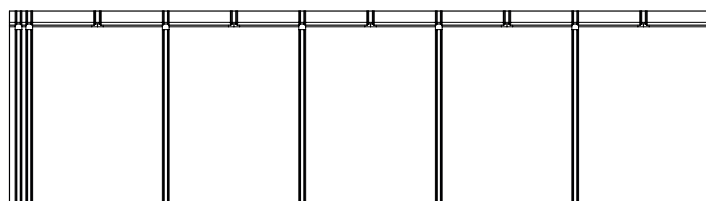
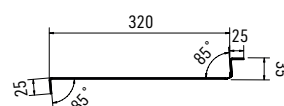
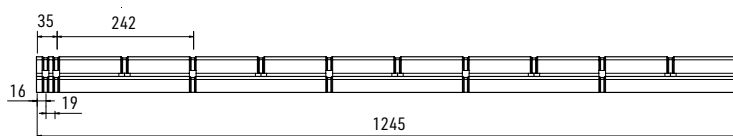

ROOF TILES



FLAT steel roof tile is new product in Blachy Pruszyński's offer. Due to modern shape it easily sets in contemporary and industrial area. Assembly is fast and easy. Waste of material is reduced to minimum. We offer wide palette of anti-corrosion coatings in many colours. Thanks to this roofs covered with FLAT tile may be designed for many years' use.

PLASKA

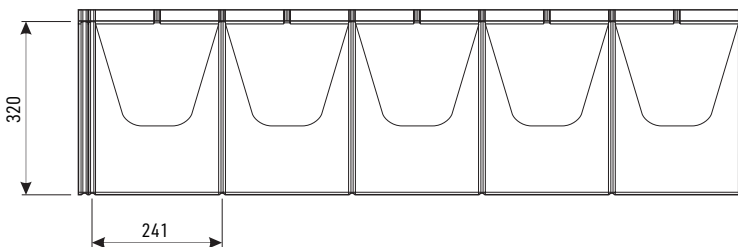
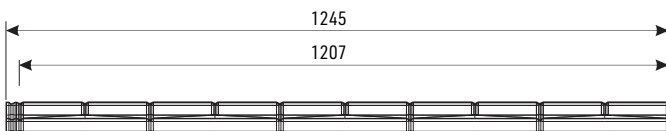
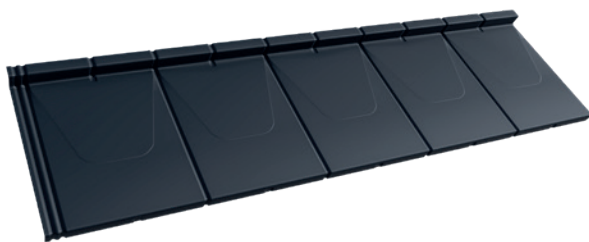

effective area	0,386 m ²
module length	320 mm
profile height	3 mm
fold height	35 mm
total width	1245 mm
effective width	1207 mm
min. roof slope	25°
coatings	PURMAT
accessories	screws, seals, sealing collars, flashings, touch-up paint



FLAT steel roof tiles has been awarded with **GOLDEN MEDAL** at Budma International Poznań Fair 2019

ROOF TILES



An important feature of **LOARA** roof tile which supports its popularity among customers is high embossment. LOARA's structure is symmetric which significantly simplifies its assembly. This modern profile is available both in cut-to-size and in modular option.

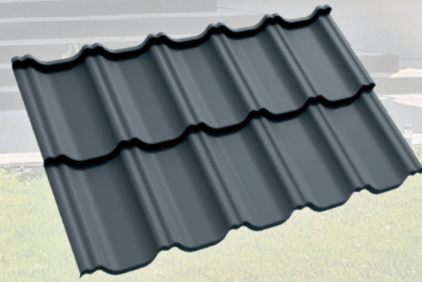

	roof tile	panel roof tile
effective area	-	0,784 m ²
module length		350 mm
profile height		23
fold height	25 mm	30 mm
total width		1187 mm
effective width		1120 mm
min. roof slope	9°	15°
coatings	PS, PMG, ULTRAMAT, PURLAK, PURMAT	PS, ULTRAMAT, TOPMAT, PURLAK, PURMAT
accessories	screws, seals, sealing collars, flashings, touch-up paint	

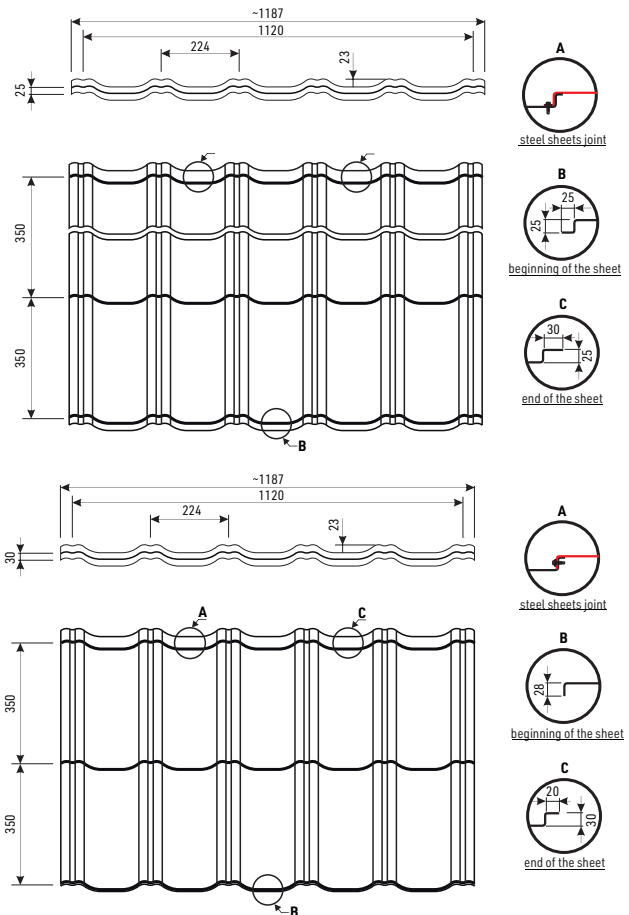

ROOF TILES

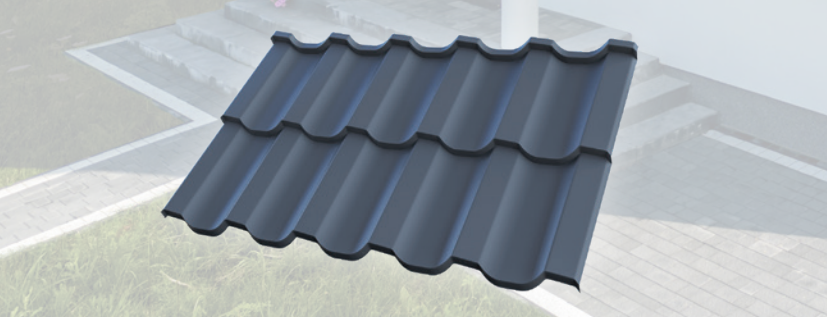

REN metal roofing tile with its unique shape allows objects to stand out against others. On the other hand it seamlessly blends into the surrounding environment. It also has a very rich palette of anti-corrosion protection (organic and metallic coatings). Hence, roofs covered with „REN“ tile can be designed for decades without the risk of losing functional properties and aesthetic values.

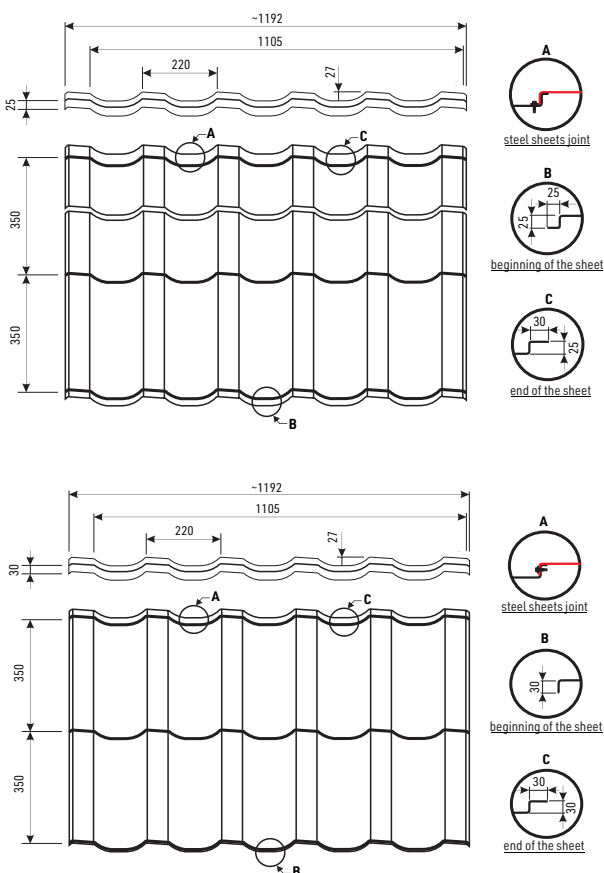

	roof tile	panel roof tile
effective area	-	0,774 m ²
module length		350 mm
profile height		27
fold height	25 mm	30 mm
total width		1192 mm
effective width		1105 mm
min. roof slope	9°	15°
coatings	PS, PMG, ULTRAMAT, PURLAK, PURMAT	PS, ULTRAMAT, TOPMAT, PURLAK, PURMAT
accessories	screws, seals, sealing collars, flashings, touch-up paint	



REN steel roof tiles has been awarded with GOLDEN MEDAL at Budma International Poznań Fair 2018

ROOF TILES

KARO panels made of coated steel are suitable for those, who appreciate original look of the roof. Panels are available in coarse matt and PURMAT coatings. However, there is a possibility to produce them in any other coating or colour from our offer. It is assembled on the roof with full boarding with use of clasp. The interesting shape of this cladding determines unique outlook of the roof. Karo panels are perfect also as chimney cladding and elevation.



dimension of panels	555x555, 345x345, 245x245 mm
steel thickness	0,5 mm
min. roof slope	22°
assembly	by means of holders, on the full-board roof
coatings	PS, PMG, PURMAT, PURLAK
accessories	clasps, sealing tapes, flashings



KARO 555 PANEL
- Starting



KARO 555 PANEL
pcs/m² - 3,25



KARO 345 PANEL
- Starting



KARO 345 PANEL
pcs/m² - 8,4



KARO 245 PANEL
- Starting



KARO 245 PANEL
pcs/m² - 16,67



CLASP
- fixing accessory



KARO Panels was awarded with
Gold Medal MTP BUDMA

TP 26 SUPER



TP 26 SUPER seems like a standard trapezoidal profile, but its range of use is very universal. It's perfect for roof of garages, sheds, barns, industrial halls and even residential houses. It can be also used as facade. Wave profilation in flat parts are available. Height of trapezoidal is 26mm. Such dimensions and span between bendings ensures correct flow of water from roof and aesthetic look.

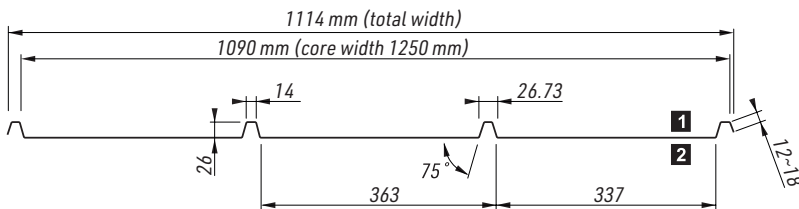
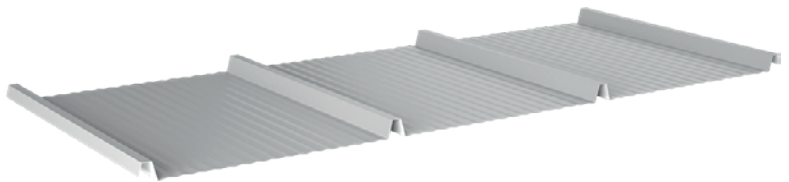

steel thickness	0,5-0,7 mm
min. length of sheet	0,5 mb
max. recommended length of sheet	0,50 mm - 6 mb 0,70 mm - 7 mb
seam height	26 mm
width of raw material	1250 mm
total width	1114 mm
effective width	1090 mm
min. roof slope	6°
coatings	PMG, ULTRAMAT, TOPMAT, PURMAT
accessories	screws, seals, sealing collars, flashings, touch-up paint

POSSIBILITY OF PROFILATION

- F - microwave



TP 26 SUPER was awarded with Gold Medal MTP BUDMA

APPLICATION:
roof of residential houses and utility facilities,
minimum slope of roof 8st (14%),
facades, fences, garage doors etc.

STANDING SEAM ROOFING PANELS



Please see our episode movies which present asseble of STANDING BEAM roof panels



BRACKET FOR SOLAR PANELS

Standing seam is one of the oldest technologies used in the craft of house building. We offer modern solution to this traditional profile. Joining the panels takes place by means of fastening without bending the seam. Each panel has assembly holes simplifying its fixing to roof construction. Factory cut out endings allow installation on a starting fascia.

NA RABEK



effective width	510 mm
seam height	25 mm
max. recommended length of sheet	nano and microwave - 9 m micro-trapezoidal - 7 m flat - 5 m
min. length of sheet	0,5 m
min. roof slope	8°
thickness	0,5/0,7 mm
coatings	PS, PMG, TOPMAT, PURMAT, PURLAK
accessories	screws, seals, sealing collars, flashings, touch-up paint

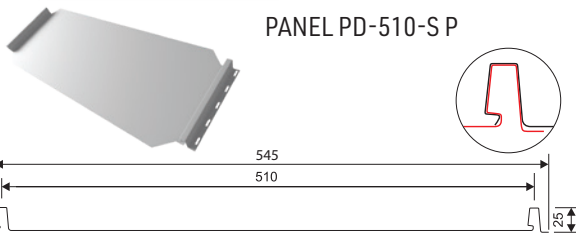

PANEL PD-510-S P

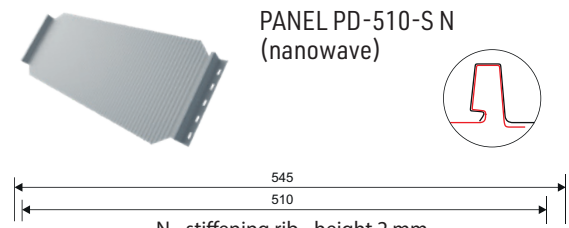

PANEL PD-510-S N (nanowave)

Deformation according to specification of material, to reduce this effect it's recommended to use steel of thicknes 0.70mm

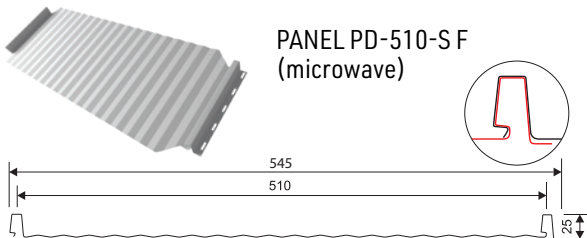

PANEL PD-510-S F (microwave)

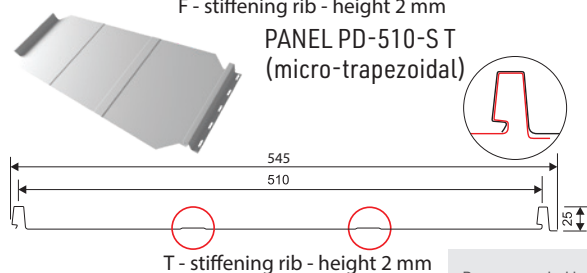

PANEL PD-510-S T (micro-trapezoidal)

PANEL JOINTS

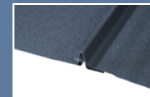

In case of the need to disassemble, the new joint allows to separate panels without damaging them.

ASSEMBLY FLASHING

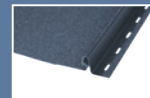

Panels are equipped with a flashing with openings allowing to assemble them directly to the roof construction.

UNDER-RIDGE BOARD



Under-ridge board with factory-made holes for screws enables fixing the panels to the roof construction.



ROOF TILES



VERONA is the latest panel steel roof tile, distinguished primarily by possibility to produce in two types of profilation. It is available in flat and nano-wave profilation. It will fit perfectly into modern buildings and will also look great on traditional roofs.

VERONA

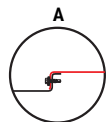
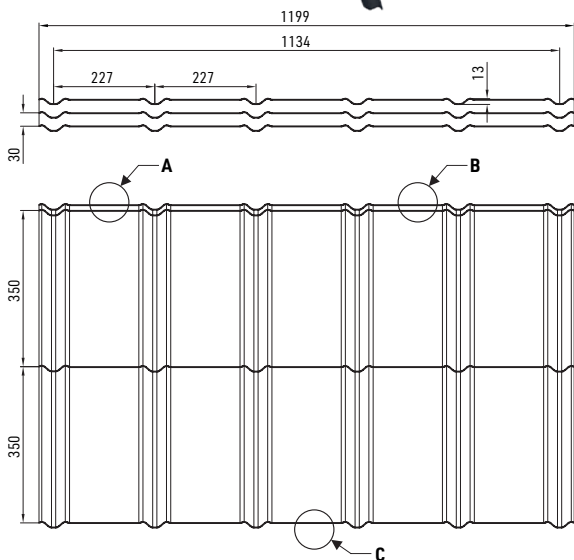

steel sheets joint

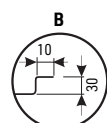

end of the sheet

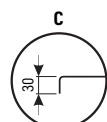

beginning of the sheet

effective area	0,777 m ²
module length	350 mm
profile height	13 mm
fold height	30 mm
total width	1199 mm
effective width	1134 mm
min. roof slope	20°
coatings	TOPMAT, PURMAT
accessories	TORX screws, seals, sealing collars, flashings, touch-up paint

AVAILABLE COLORS:

- RAL 7016
- RR 033

ROOF TILES



MODUS is a metal roofing tile delivered as panels for traditional assembly with use of screws. Available coatings are: glossy and coarse-grained matt polyester, polyurethane - PURMAT and PURLAK, also hybrid coating - PURMAX.

MODUS



effective area	0,756 m ²
module length	350 mm
profile height	35 mm
fold height	25 mm
total width	~1179 mm
effective width	1080 mm
min. roof slope	15°
coatings	PS, ULTRAMAT, TOPMAT, PURLAK, PURMAT
accessories	screws, seals, sealing collars, flashings, touch-up paint

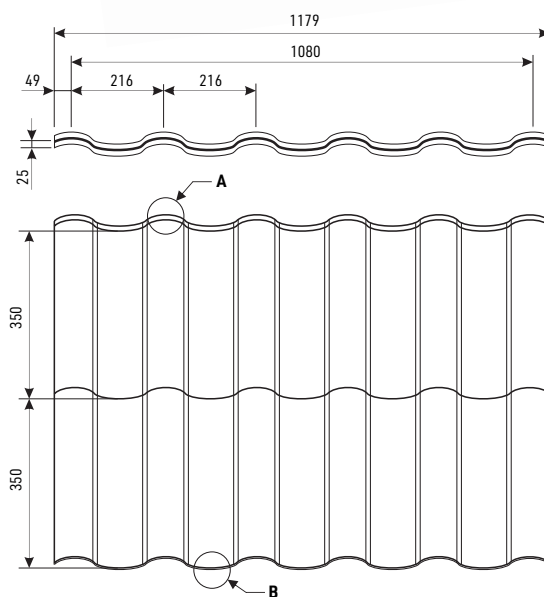

steel sheets joint



end of the sheet



beginning of the sheet



MODUS roof tile has been awarded with European Medal XXIV Edition

ROOF TILES



OPTIMA roof tile is produced in length adequate to customer's order. Assembly of the sheets takes place in way typical for Pruszynski's roof tiles. OPTIMA is available in all coatings, in 27 basic colours from RAL and RR chart.

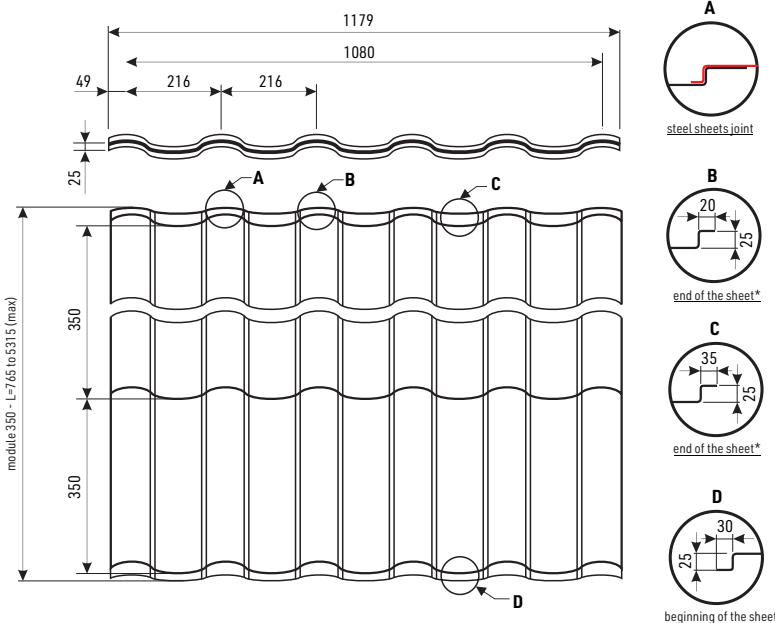

module length	350 mm
profile height	35 mm
fold height	25 mm
total width	~1179 mm
effective width	1080 mm
min. roof slope	9°
coatings	PS, PMG, ULTRAMAT, PURLAK, PURMAT
accessories	screws, seals, sealing collars, flashings, touch-up paint

* To join the sheets along their length, it is necessary to consider folds - 30 mm in the front and 35 mm in the back. Total of folds in a sheet with full back crease is 65 mm.

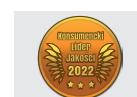

ROOF TILES



See our assembly video instruction of steel roof tiles:
https://www.youtube.com/watch?v=VM5MPDE8_Dg



Steel tile **RUBIN** is one of the most economical roofing materials. Thanks to its light weight (ca. 4.7 kg/1m²) it does not require the use of heavy roof truss structure, which results in decrease in use of wood. The weight of materials is also very important in case of renovation of roof construction.

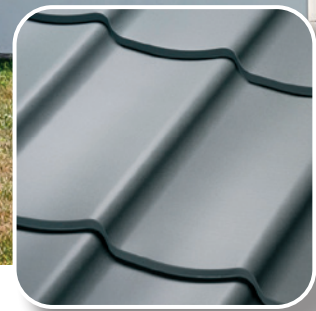

RUBIN



module length	350 lub 400 mm
profile height	20 mm
fold height	15 lub 20 mm
total width	1206 mm
effective width	1150 mm
min. roof slope	9°
coatings	PS, PMG, ULTRAMAT, PURLAK, PURMAT
accessories	screws, seals, sealing collars, flashings, touch-up paint

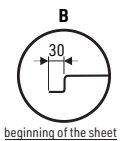
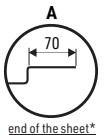
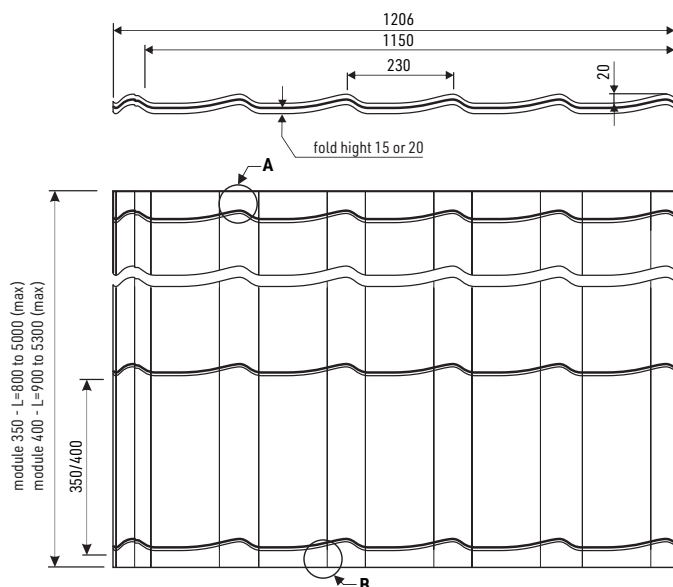

ROOF TILES

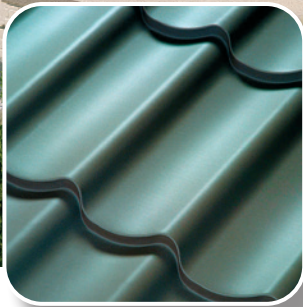

Wide range of colours allows matching the roof with elevation and surroundings. Due to defined length of sheets, the quantity of wasted material is cut down to minimum. Blachy Pruszyński steel tiles are covered with warranty period up to 50 years (depending on the type of coating).
Now SZAFIR roof tile is available also in modular mode!

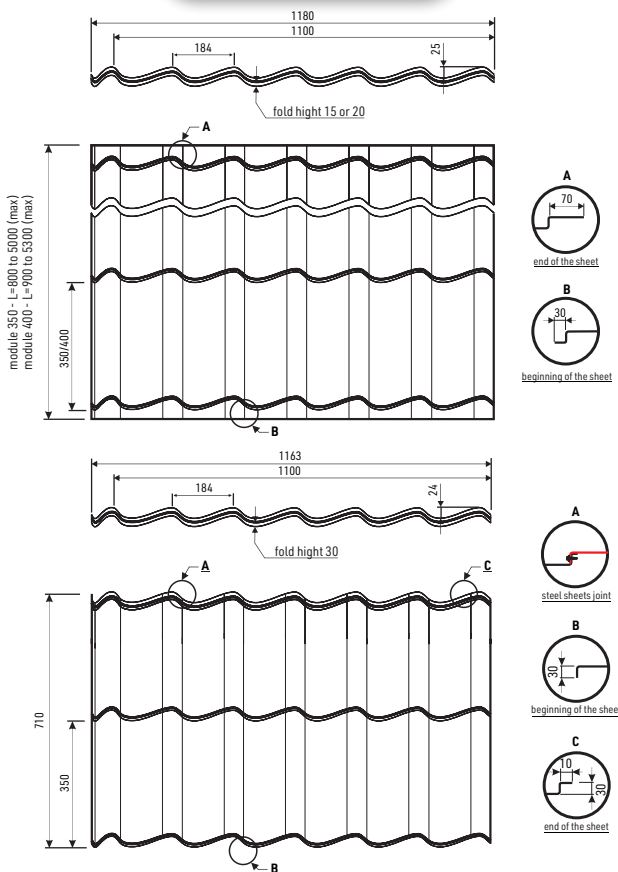

	roof tile	panel roof tile
effective area	-	0,77 m ²
module length		350 mm
profile height		25
fold height	15 lub 20mm	30 mm
total width	1180 mm	1163 mm
effective width	1100 mm	1100 mm
min. roof slope	9°	15°
coatings	PS, PMG, ULTRAMAT, PURLAK, PURMAT	PS, ULTRAMAT, TOPMAT, PURLAK, PURMAT
accessories	screws, seals, sealing collars, flashings, touch-up paint	

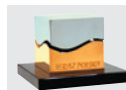

SZAFIR steel roofing tiles have been awarded with the 13th edition of **Teraz Polska (Now Poland) Polish Promotional Emblem**



ROOF TILES

REGLE IS NOW AVAILABLE
IN A NEW COATING

BLACKMAT

NEW!

For details and availability, ask at the retail point.

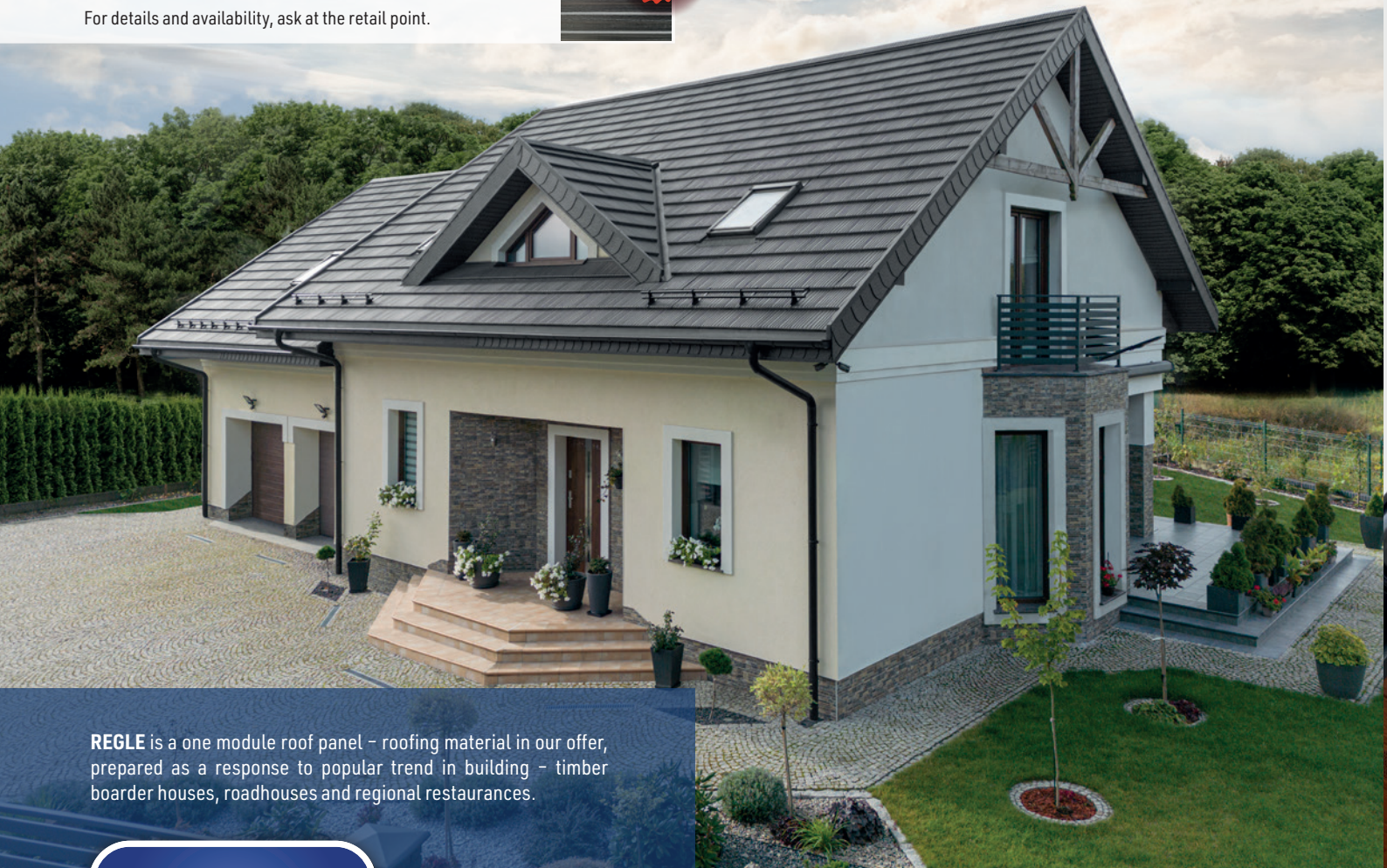

REGLE is a one module roof panel – roofing material in our offer, prepared as a response to popular trend in building – timber boarder houses, roadhouses and regional restaurants.

REGLE



effective area	0,446 m ²
module length	370 mm
profile height	5 mm
fold height	34 mm
total width	1223 mm
effective width	1205 mm
min. roof slope	25°
coatings	PURLAK, PURMAT
accessories	screws, seals, sealing collars, flashings, touch-up paint

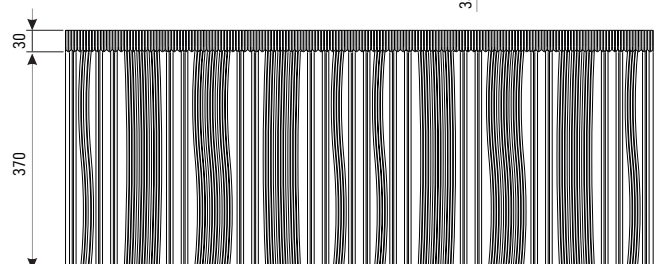
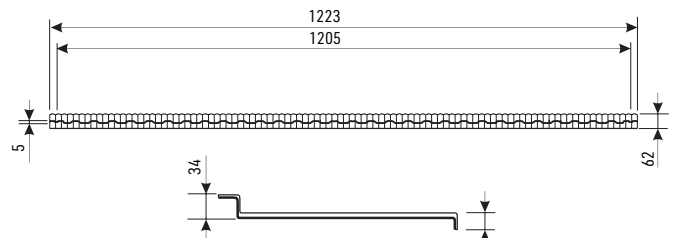

REGLE Roof panel
has been awarded with TOP BUILDER 2015
Award and Gold Medal of MTP BUDMA 2015



PERFORATED SOFFIT TP-7P

Soffit of perforated trapezoidal sheet TP-7P is convenient replacement of standard PVC soffits. Among many benefits we can list:

- possibility of perfect matching with colour of roof;
- no waving of material and better stiffness than plastic
- resistance to ageing and discoloration;
- simplicity of assembly
- possibility of ordering the convenient length

Available colours:

- golden oak polyester;
- walnut – matt polyester;
- black – coarse matt polyester R033;
- brown – coarse matt polyester 8017;

Other colours are available per individual order.

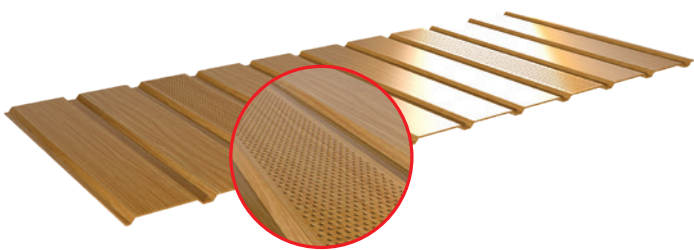

Example soffit assembly with use of „J” board fixed to elevation.

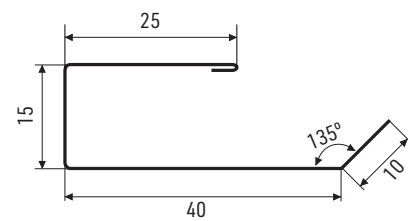

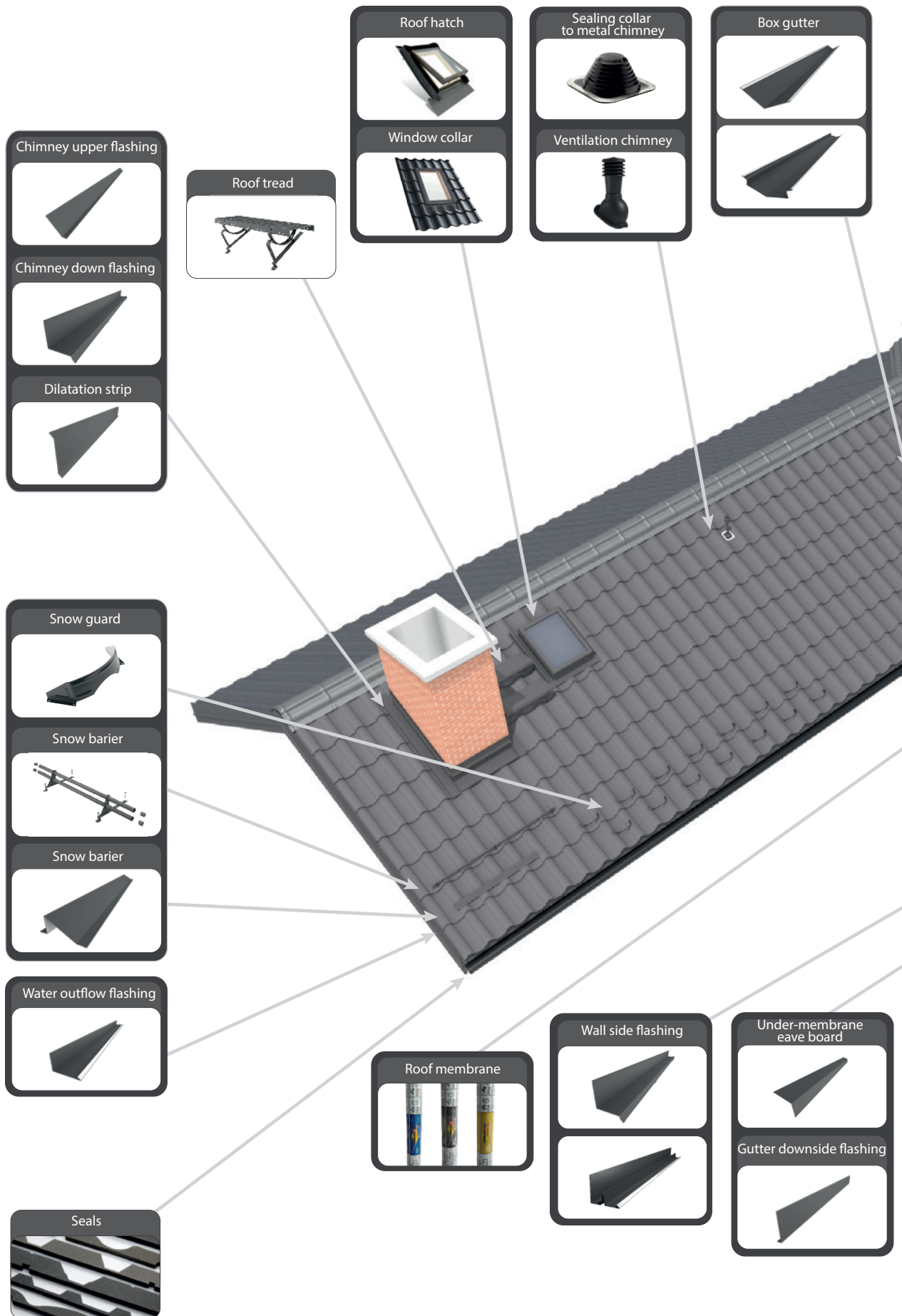

FLASHINGS AND ROOF ACCESSORIES

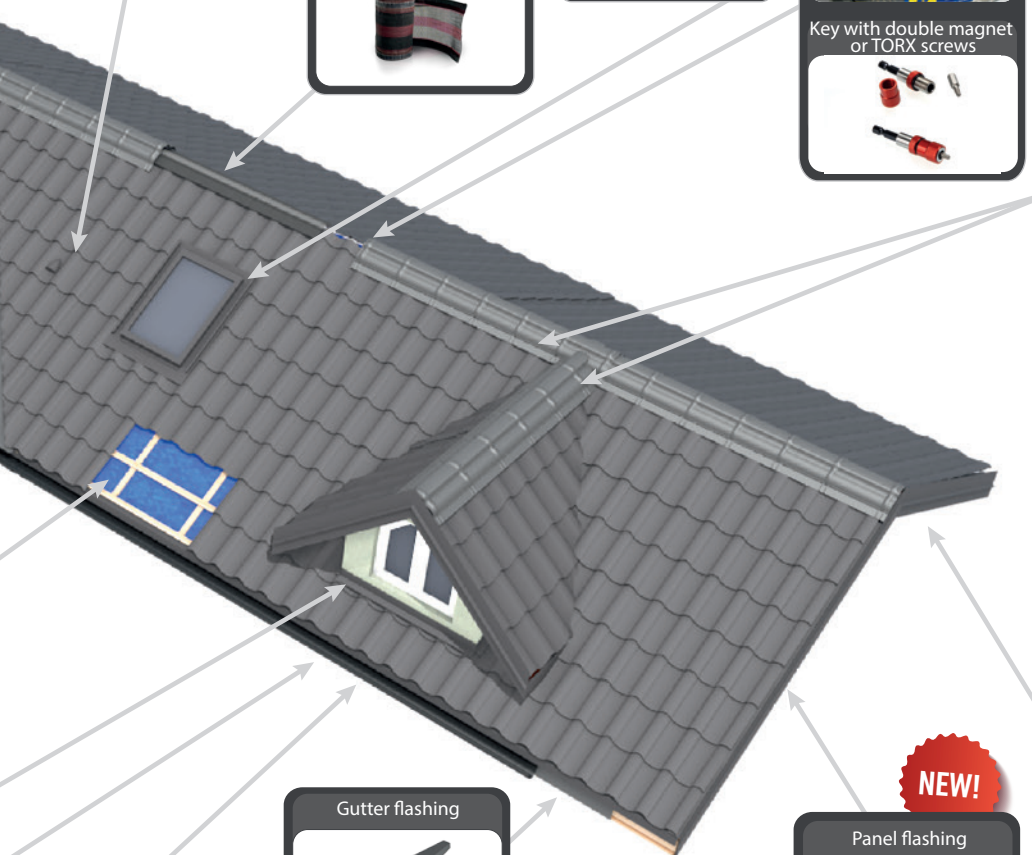
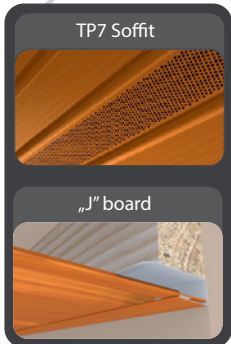
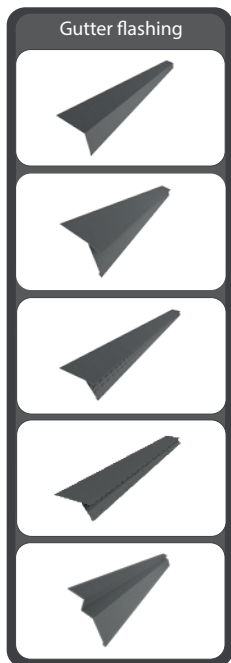
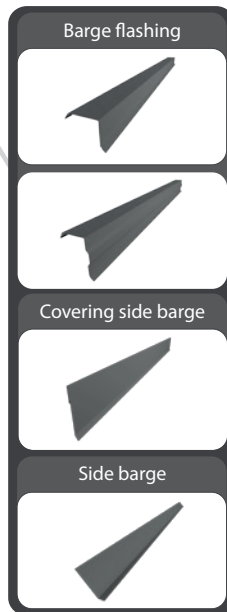
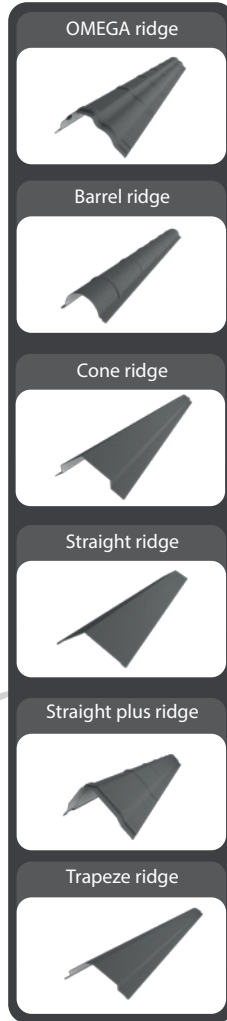
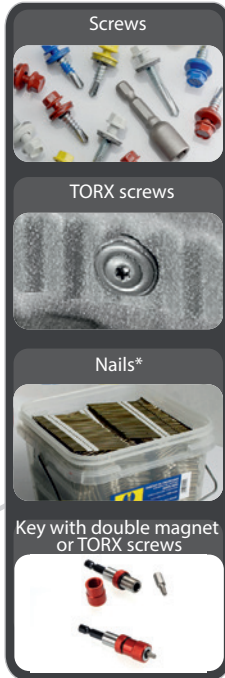

*to be used with REGLE roof panel



Roof windows AURA

The line of windows manufactured by experienced Scandinavian manufacturer according to specification created exclusively for our company.

We offer our customers 4 types of windows: GOLD+ PVC, GOLD+, BRONZE+ PVC and BRONZE+. Roof windows AURA can be assembled in roofs of pitch 15 to 90 degrees.



dimensions

66 x 118
78 x 98
78 x 118
78 x 140



GOLD+ PVC line windows

GOLD+ PVC are the most advanced windows made of PVC profile strengthened with aluminium profile which guarantees durability and protection from humidity. This fact makes them an excellent choice for kitchens and bathrooms. This window is easy to install and each package contains step-by-step assembly manual. Triple glazed pane delivers brilliant thermal parameters - $U_g 0,8 W/m^2K$ and $U_w 1,1 W/m^2K$.



dimensions

66 x 118
78 x 98
78 x 118
78 x 140



Window from line GOLD+

AURA GOLD Window is produced with wooden frame made of selected pinewood. All resources are from renewable forests and signed by FSC certificate. Special collar with foamed polyurethane ensures minimum loss of heat and better insulation. Self-cleaning layer on AURA GOLD glass prevents from formation of dirt or deposits.



dimensions

66 x 118
78 x 118
78 x 140



Window from BRONZE+ PVC line

A PVC window reinforced with an internal steel profile, ensuring durability and protection against moisture, making it an excellent choice for kitchens and bathrooms. It provides optimal air circulation thanks to two passive ventilation positions integrated into the window handle.

Key features of BRONZE+PVC windows:

- Resistance to harsh weather conditions such as heavy rain, hail, and intense snowfall, thanks to the tempered outer pane.
- Four seals ensuring complete water- and wind-tightness.



dimensions

66 x 118
78 x 118
78 x 140



Window from BRONZE+ line

A window made from carefully selected pine wood. It provides optimal air circulation thanks to two passive ventilation positions integrated into the window handle.

Key features of BRONZE+ windows:

- Reinforced wooden frame, vacuum-impregnated with fungicidal and insecticidal treatments. The raw materials used for the wooden components come from sustainably managed renewable forests.
- Excellent thermal insulation performance without the need for additional accessories.



WINDOWS

ROOF HATCH WINDOW

dimensions

45x73

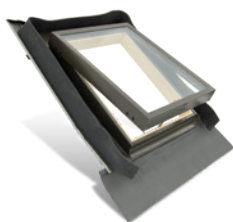

Roof hatch is used for no heated and unoccupied spaces. Integrated collar provides perfect tightness and easy assembly in all kinds of roof coverings. AURA hatch can be assembled in roofs of pitch 15 to 60 degrees. Double pane package 14 mm(3-8-3). Two methods of opening: up or on side.

COLLARS FOR ROOF WINDOWS

flat	
symbol	dimensions
KPS GP 55x78	55x78
KPS GP 55x98	55x98
KPS GP 66x118	66x118
KPS GP 78x98	78x98
KPS GP 78x118	78x118
KPS GP 78x140	78x140
corrugated	
symbol	dimensions
KFS GP 55x78	55x78
KFS GP 55x98	55x98
KFS GP 66x118	66x118
KFS GP 78x98	78x98
KFS GP 78x118	78x118
KFS GP 78x140	78x140

combo	
symbol	dimensions
KFK 13E GP	78x118
KFK 2E GP	78x118
KFK 46E GP	78x118
KFK 5E GP	78x118
KFK 13E GP	78x140
KFK 2E GP	78x140
KFK 46E GP	78x140
KFK 5E GP	78x140
to the seam	
symbol	dimensions
KRS GP 78x118	78x118
KRS GP 78x140	78x140

Collar ensures easy assembly and full waterproofness. Collars are made of aluminium and painted with grey – the same as window. Collars are resistant to weather conditions and UV radiations, its waterproofness have been tested according to tight norms.

ROLLERS

darkening		
colour	symbol	dimensions
dark blue	DURC2A 4212	55x78
	DURF6A 4212	66x118
	DURM4A 4212	78x98
	DURM6A 4212	78x118
	DURM8A 4212	78x140
beige	DURC2A 4219	55x78
	DURF6A 4219	66x118
	DURM4A 4219	78x98
	DURM6A 4219	78x118
	DURM8A 4219	78x140
white	DURC2A 4208	55x78
	DURF6A 4208	66x118
	DURM4A 4208	78x98
	DURM6A 4208	78x118
	DURM8A 4208	78x140
light darkening		
colour	symbol	dimensions
dark blue	RHR CXA 4312	szer. 55
	RHR FXA 4312	szer. 66
	RHR MXA 4312	szer. 78
beige	RHR CXA 4319	szer. 55
	RHR FXA 4319	szer. 66
	RHR MXA 4319	szer. 78
awning		
colour	symbol	dimensions
black	MIR CXA 4260	szer. 55
	MIR FXA 4260	szer. 66
	MIR MXA 4260	szer. 78

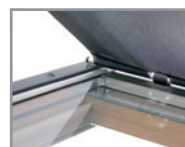

external		
colour	symbol	dimensions
gray	SHR C2A	55x78
	SHR F6A	66x118
	SHR M4A	78x98
	SHR M6A	78x118
	SHR M8A	78x140



Internal and external rollers are high quality products suitable for all AURA® and do not require any additional regulating. Therefore it is very easy to install it. All you need is follow the instruction attached to every roller. On the top part of window sash there is a data plate with model and measurements of the roof window.

DARKENING ROLLER BLIND DUR. Even 100% of darkening – ideal for bedrooms or rooms where high scope of light regulation is compulsory.

LIGHT DARKENING ROLLER RHR. Effectively spread the light. Allows to stop the roller in 3 fixed positions.

AWNING MIR. External awning, which protects against heating and reduces the noise of rain.

ASSEMBLY ACCESSORIES

THERMAL INSULATION COLLAR FROM EXPANDED POLYETHYLENE IFC. Perfect thermal insulation and sealing of the window.

IFC collar makes sealed frame around the window to protect the interior against heat loss.

COLLAR OF WATER VAPOUR PERMEABILITY RUC. Reduces the time of roof window assembly. Designed to protect the roof and ensure waterproofness of roof construction.

EXTENDED HANDLE ZAR. ZAR handle are suitable for all windows. Handles are produced from metal and finished with rubber. Available in length 80 and 120 cm.

ELECTRICAL OPENER AMC. Electrical opener AMC 100 allows to regulate the width of the opened window from 10 cm up to 40 cm, equipped in remote controller. AMC 100 is marked with **CE** and 2 years warranty.



Niagara gutters are available in 8 sizes

System 110/90	System 125/90	System 125/100	System 150/100
System 150/120	System 150/150	System 190/120	System 190/150

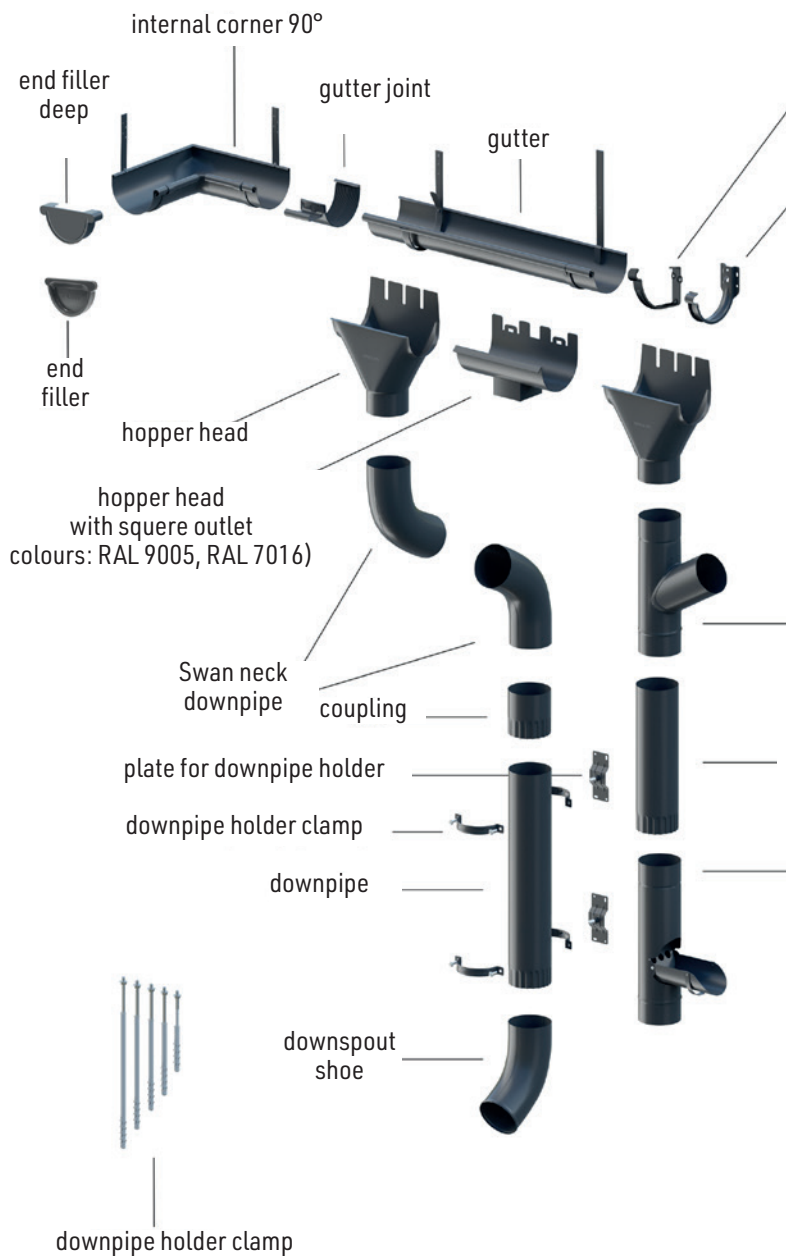

STEEL GUTTERS POLYURETHANE

Steel gutters with polyurethane covering are standing out due to wide pallet of available colours. Thanks to that, it's easy to match colours of gutter system to roof and façade of buildings. Additional advantage is high resistance to change of colours and effects of weathering.



GALVANISED

The main advantage of galvanised gutter system is good price and short time of realization of orders with main properties of NIAGARA Gutter system. This material is perfect for agricultural and industrial facilities, but can be used as well in residential houses

COLOUR

POLYURETHANE



Steel gutter system NIAGARA was awarded „Consumer Lider of Quality 2017”



NIAGARA GUTTER SYSTEM

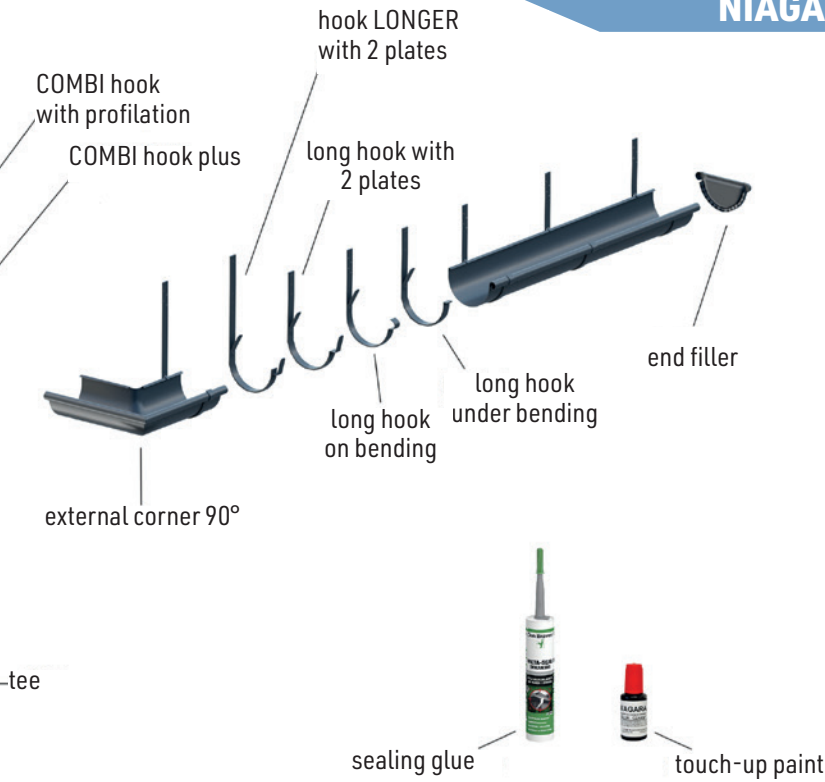

downpipe connector 0,5 mb

Rainwater collector

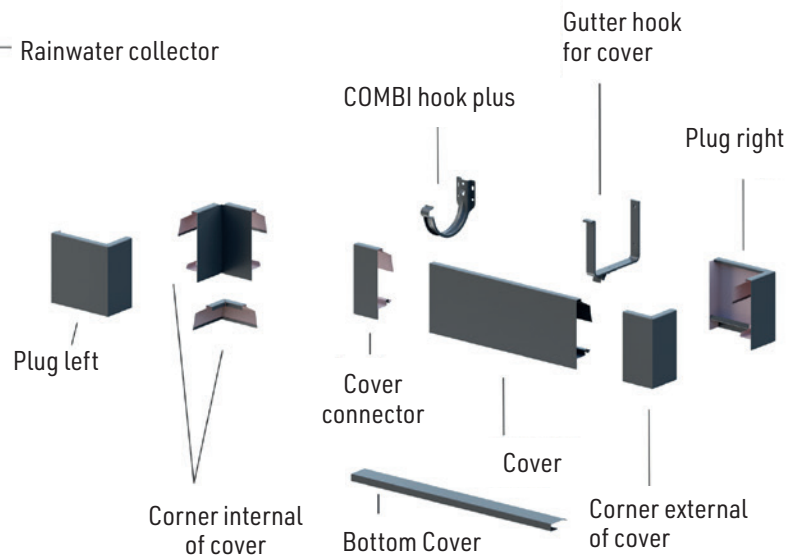

Masking elements are available only in PURMAT coating in colours BLACK-RR033 and ANTHRACITE RAL 7016

ALUMINIUM - TYTANIUM



TITAN-ZINC

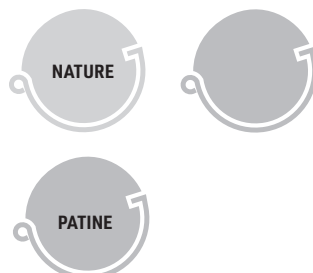

GALVANISED



ALUMINIUM - TYTANIUM

Aluminium gutter system **TYTANIUM** is recommended in surroundings of high pollution, seaside and forested. Due to durability this product was awarded on International Industrial Fairs BUDMA 2015. Use of aluminium means low self-mass and possibility of assembly in temperatures from -15 to +40°C.

TITAN - ZINC

TITAN-ZINC is characterised with classic, elegant look and over 100 years durability. It's available in 2 versions: NATURA and PATYNA. It's used both in new building and during renovations of historic buildings. It has high resistance to corrosion and weather conditions (acid rains included).

NIAGARA GUTTER SYSTEM

K N I A G A R A
W A D R A T O W A



NIAGARA GUTTER SYSTEM

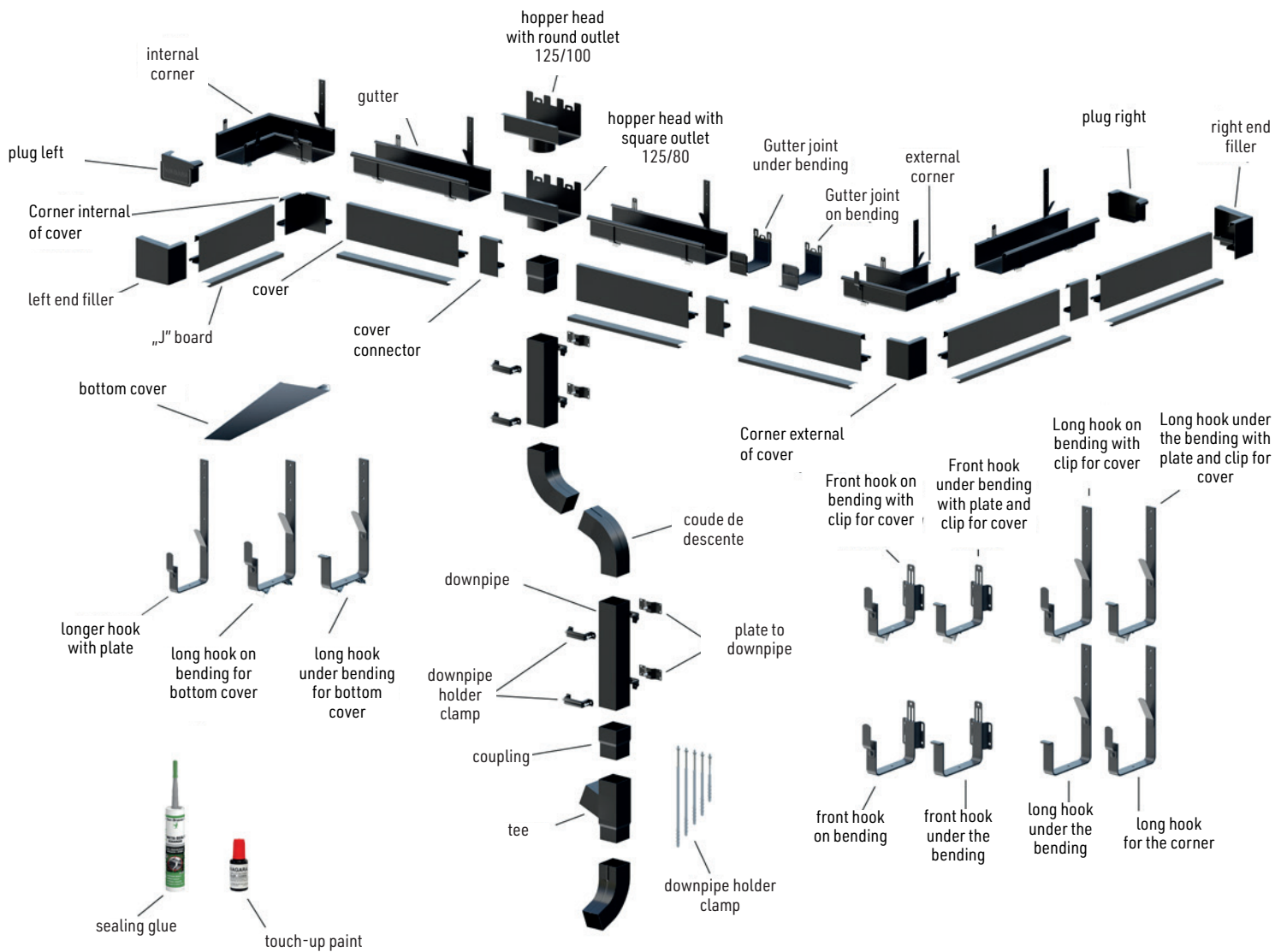

Masking elements are available only in PURLAK coating in colours ANTHRACITE and BLACK

Modern shape of the guttering system fulfills high-technology buildings. System of gutters offered by our company builds up complete water drainage of the roof. It has been designed thinking of aesthetics and efficiency, but most of all of durability. Our technology enabled us to create products which amaze not only with their technical parameters, but also with their visual features. Quality of our products is **QUALITY SQUARED**.

COLOURS



Blachy Pruszyński's Company offers a wide variety of accessories such as: standard and non standard flashings, windows and roof hatches, screws, sealing, sealing collars, roof foils, roof ventilation, touch-up paints and flat sheet.

Blachy Pruszyński's offer also includes: production of standard and non-standard flashings, cutting flat sheet from sheets into sections, punching assembly holes, bending steel on press brake and angle bending machines.

Our plant could also perform flashings from steel thickness 3,0 mm and maximum length 7 m.

NEW! Our roof flashings are now available with nanowave profilation.

**ROOF FLASHINGS AVAILABLE NOW
WITH NANOWAVE PROFILATION**

Standard ridges - available on stock.

BARREL RIDGE

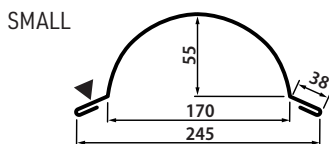
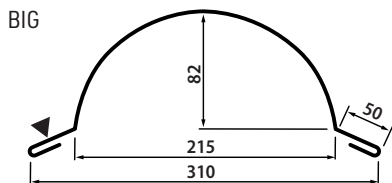

OMEGA RIDGE

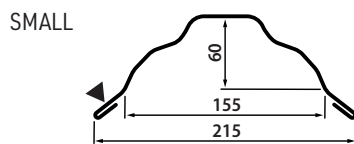
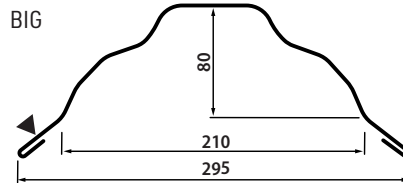

REMEMBER
of end flashing
for OMEGA ridge

STRAIGHT RIDGE 'PLUS'

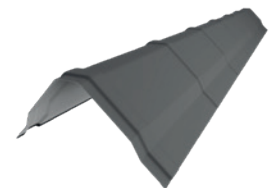
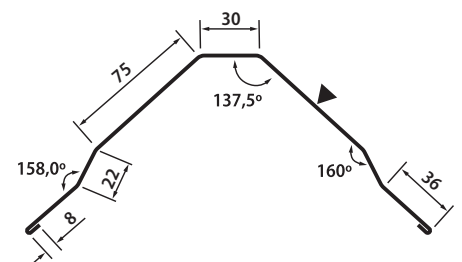

Ridges are manufactured on a bending machine - on request. The bending angle can be changed according to the customer's needs.

TRAPEZE RIDGE

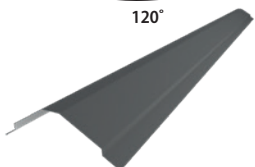
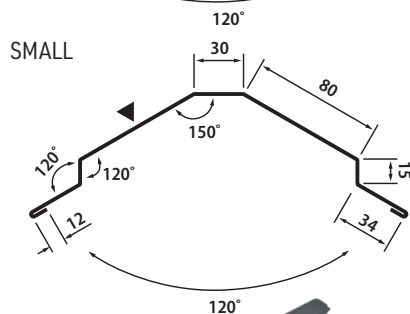
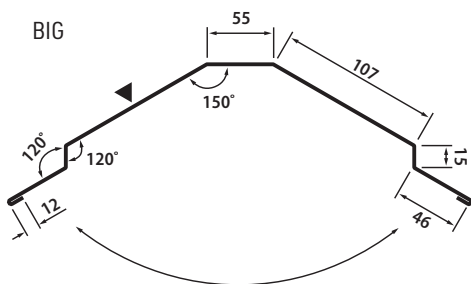

STRAIGHT RIDGE

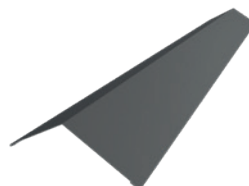
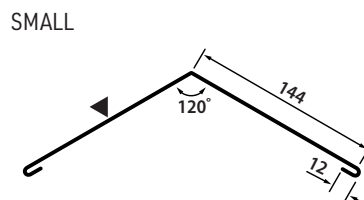
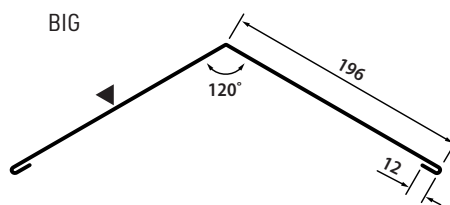

CONE RIDGE

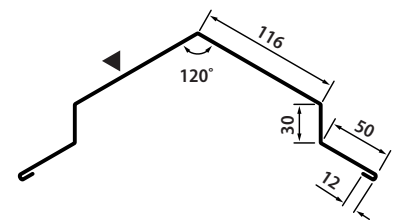

▼
Mark of side of colour

ACCESSORIES

Box gutters are made on a bending machine - on request. The bending angle can be changed according to the customer's needs.

DEEP BOX GUTTER

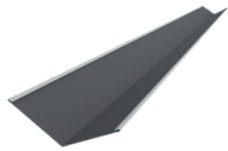
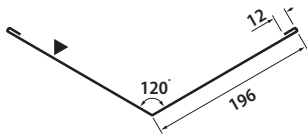

FOR ONE-PANEL ROOF TILES

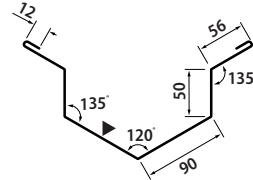

Other flashings are made on bending machines.

GUTTER FLASHING

FOR ROOF TILES
AND TRAPEZOIDAL PROFILES

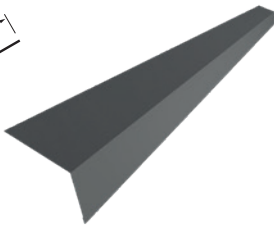
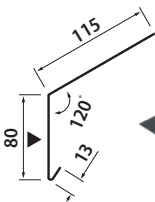

OVERGUTTER STRIP

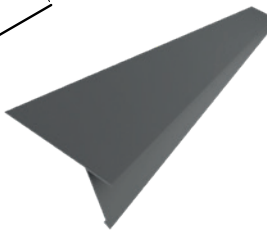
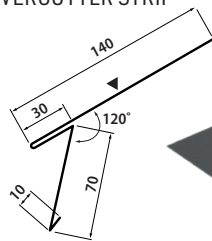

EAVE BOARD FOR MEMBRANE

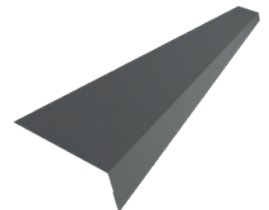
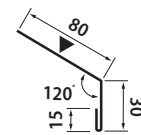

FOR ONE MODULE ROOF TILES

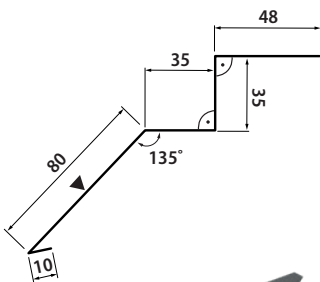

OVERGUTTER STRIP,
TWO ROWS OF VENTILATION HOLES

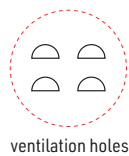
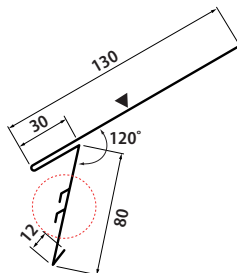

OVERGUTTER STRIP,
THREE ROWS OF VENTILATION HOLES

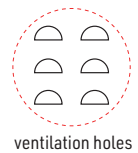
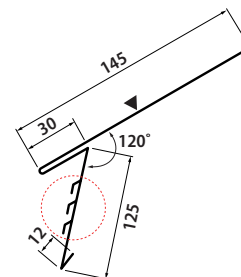

CLOSING PLATE FOR TRAPEZOIDAL SHEET | RIDGE SIDE

FOR PROFILES T18 - T92*

thickness - 0,5 mm

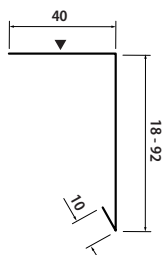
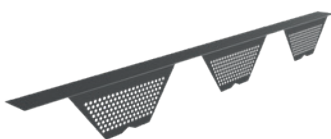

Closing plates can be without perforated.

Closing plates are available in all color of PMG coating (7 colors) and 3 gloss colors - PS RAL 9007, PS RAL 9006, PS RAL 9010.

Other colours available with +50% retail price.

***Does not apply to TP26 SUPER trapezoidal sheet metal. For this model, we recommend using the dedicated TP26 SUPER under-ridge board.**

CLOSING PLATE FOR TRAPEZOIDAL SHEET | EAVE SIDE

FOR PROFILES T18 - T92

thickness - 0,5 mm

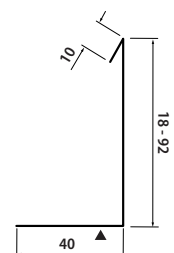
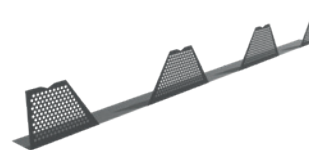

Closing plates can be without perforated.

Closing plates are available in all color of PMG coating (7 colors) and 3 gloss colors - PS RAL 9007, PS RAL 9006, PS RAL 9010.

Other colours available with +50% retail price.

WATER OUTFLOW FLASHING

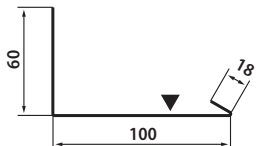

Water outflow flashing can be paired with covering side barge

COVERING SIDE BARGE

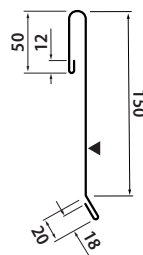

DILATATION STRIP

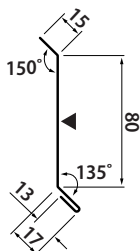

Dilatation strip can be paired with wall side flashing

WALLSIDE FLASHING

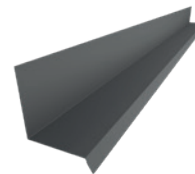
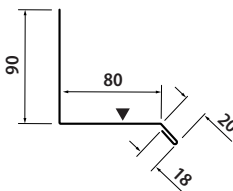

WITH OUTFLOW GUTTER



PANEL SIDE-FLASHING

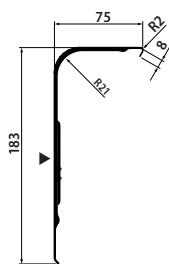

NEW!



Universal side-flashing is compatible with all our models of steel roof tiles. Available in 2-module version in matt covering and colors RAL 7016 and RR033. Requires use of drain flashing.

ATTENTION!

Side-flashing are in right and left version.

DRAIN FLASHING

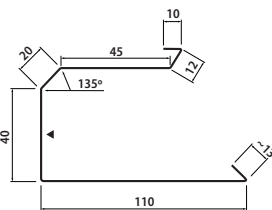

NEW!



BOARD FLASHING FOR PANEL SIDE-FLASHING

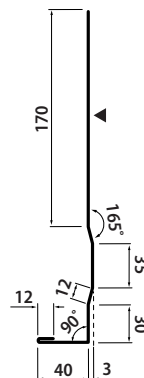

NEW!



ACCESSORIES

EAVE VENTILATION BATTEN

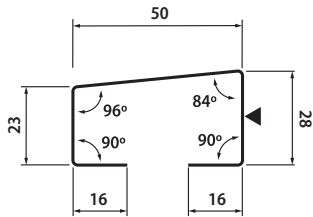

Eave batten is available in 3 colors of PMG coating (RAL 7016, RAL 8017 oraz RR 033).
It's obligatory item during assembly of steel rooftiles.

'J' BOARD

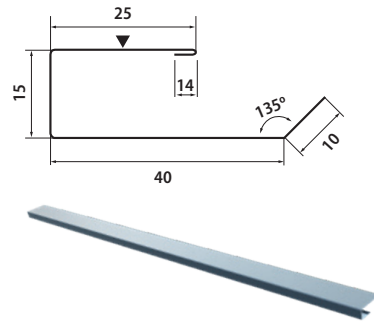

UNDER-RIDGE BOARDS

FOR STANDING SEAM ROOFING PANELS

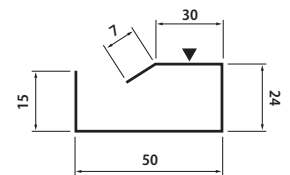

Under-ridge boards are available in all colour of PMG coating (7 colors) and 3 gloss colors - PS RAL 9007, PS RAL 9006, PS RAL 9010.

It's produced in 2 lengths:

- 0,5m - for roofs with panels with standing seam
- 2 m - for roofs with flat rooftiles

FOR TP26 SUPER

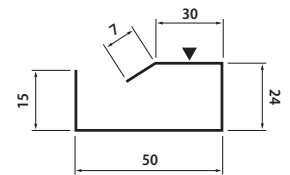

Under-ridge boards are available in colours: PMG RAL 7016, PMG RR 033 i PMG RR 011.

Length: 1109 mm

FOR FLAT ROOF TILES

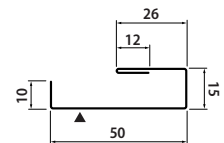
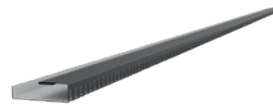

BOARD FLASHING

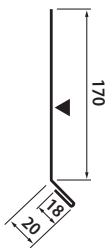

BARGE FLASHING

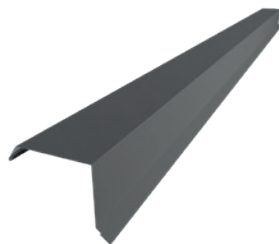
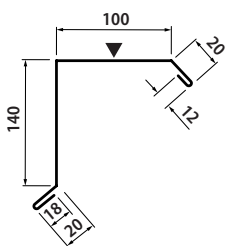

WITH PROFILATION

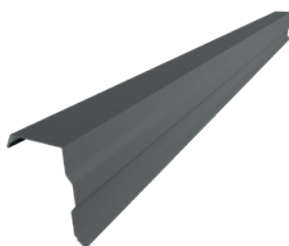
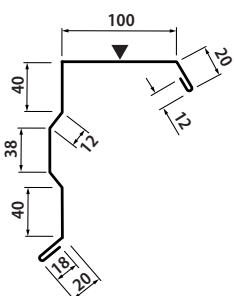

UNDER GUTTER STRIP

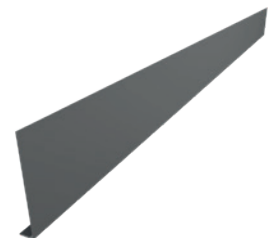

We constantly keep on updating our offer and introduce new products. Ask our local distributor in your area or our Sales Department to get information about flashings made of steel with nanowave embossing.



Mark of side of colour

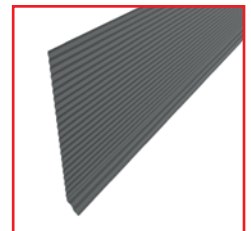

TRAPEZOIDAL PROFILES

ATTENTION:

- 1** trapezoidal sheet is coated with decorative coating,
- 2** trapezoidal sheet is coated with protective coating (primer)

ROOFING PROFILES

T 14 roof

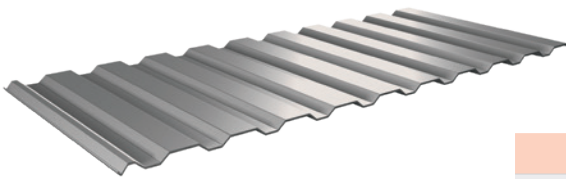

≠0,50 length max 6 lm
≠0,70 length max 7 lm

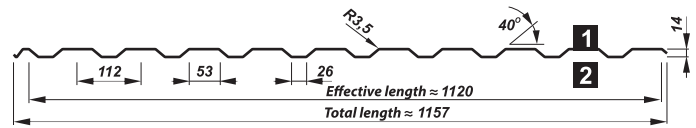

COATING:					STEEL SHEET THICKNESS:
polyester		polyurethane	zinc	aluzinc	od 0,50 mm to 0,70 mm
glossy	matt	50 µm	200, 275 g/m ²	150, 185 g/m ²	

T 18 galvanised roof

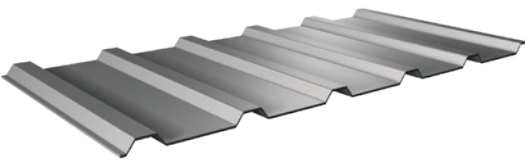

≠0,50 length max 7 lm
≥0,60 length max 8 lm

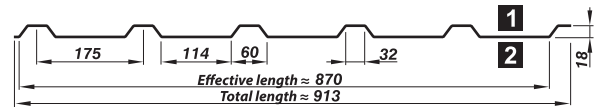

COATING:		STEEL SHEET THICKNESS:
zinc		od 0,50 mm to 0,80 mm
200, 275 g/m ²		

T 18 DR roof

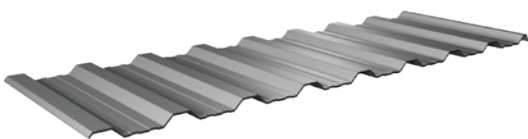

≠0,50 to 0,80 length max 9 lm

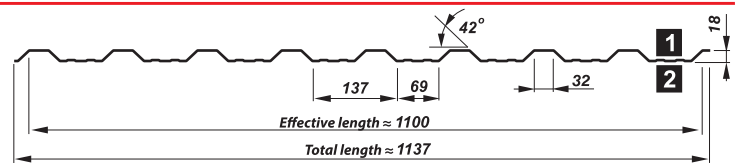

COATING:					STEEL SHEET THICKNESS:
polyester		polyurethane	zinc	aluzinc	0,50 mm to 0,80 mm
glossy	matt	50 µm	200, 275 g/m ²	150, 185 g/m ²	

T 18 roof

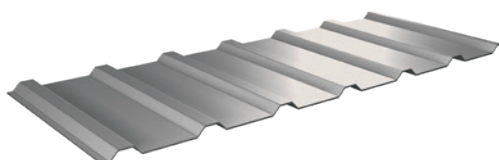

≠0,50 to 0,80 length max 9 lm

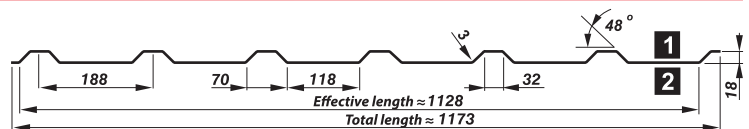

COATING:					STEEL SHEET THICKNESS:
polyester		polyurethane	zinc	aluzinc	0,50 mm to 0,80 mm
glossy	matt	50 µm	200, 275 g/m ²	150, 185 g/m ²	

TRAPEZOIDAL PROFILES

T 18P roof

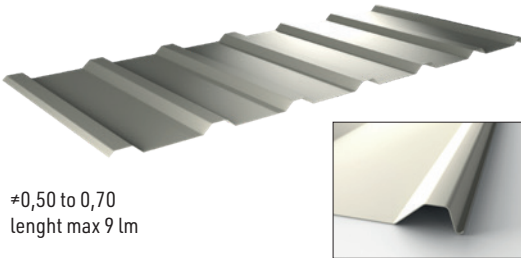

≠0,50 to 0,70
length max 9 lm

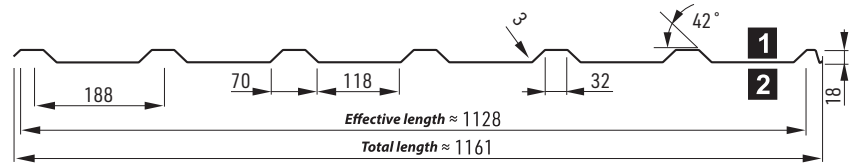

COATING:			STEEL SHEET THICKNESS
polyester		polyurethane	0,50 mm to 0,70 mm
glossy	matt	50 µm	
25 µm	35 µm		

T 20 roof

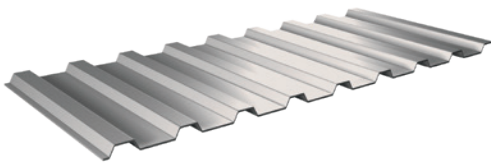

≠0,50 to 0,75 length max 9 lm

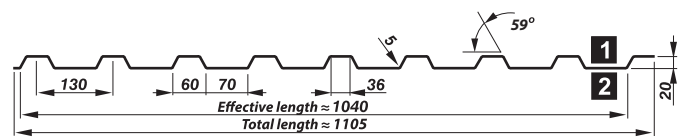

COATING:				STEEL SHEET THICKNESS
polyester		polyurethane	aluzinc	0,50 mm to 0,75 mm
glossy	matt	50 µm	150, 185 g/m ²	
25 µm	35 µm			

TP26 SUPER

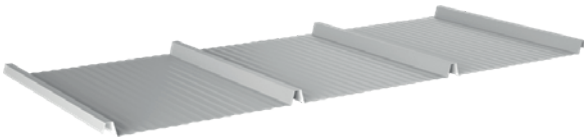

≠0,50
length max 6 lm

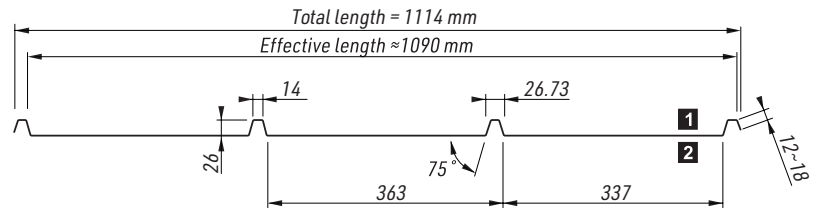

COATING:				STEEL SHEET THICKNESS
polyester		polyurethane	aluzinc	0,50 mm to 0,70 mm
glossy	matt	50 µm	150, 185 g/m ²	
25 µm	35 µm			

T 35 roof

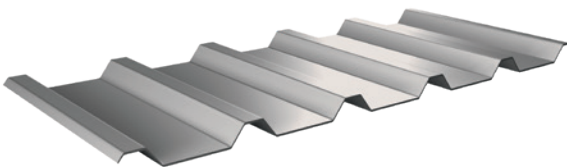

≠0,50 length max 9 lm
≥ 0,70 length max 12 lm

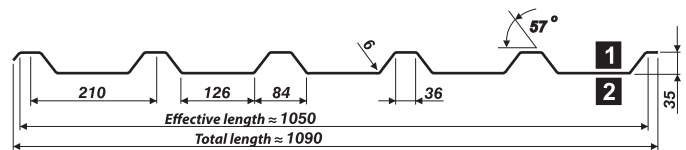

COATING:				STEEL SHEET THICKNESS
polyester		polyurethane	zinc	0,50 mm to 1,00 mm
glossy	matt	50 µm	200, 275 g/m ²	
25 µm	35 µm		150, 185 g/m ²	

T 40 roof

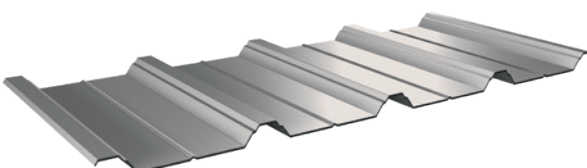

≠0,50 length max 9 lm
≥ 0,70 length max 12 lm

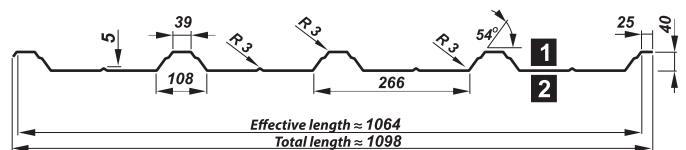

COATING:				STEEL SHEET THICKNESS
polyester		polyurethane	zinc	0,50 mm to 1,0 mm
glossy	matt	50 µm	200, 275 g/m ²	
25 µm	35 µm		150, 185 g/m ²	

TRAPEZOIDAL PROFILES

T 45 roof

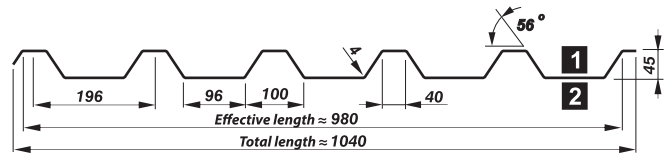
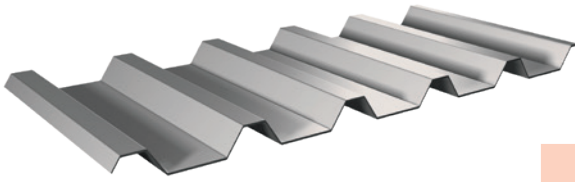

COATING:					STEEL SHEET THICKNESS
polyester		polyurethane	zinc	aluzinc	0,50 mm to 1,00 mm
glossy	matt				
25 µm	35 µm	50 µm	200, 275 g/m ²	150, 185 g/m ²	

≠0,50 length max 9 lm
 ≥ 0,70 length max 12 lm

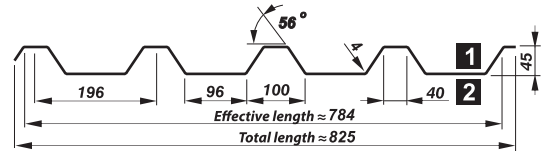

COATING:				STEEL SHEET THICKNESS
zinc				0,50 mm to 1,00 mm
200, 275 g/m ²				

T 45P roof

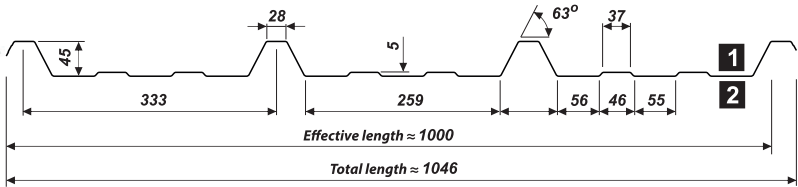

COATING:					STEEL SHEET THICKNESS
polyester		polyurethane	zinc	aluzinc	0,50 mm to 0,70 mm
glossy	matt				
25 µm	35 µm	50 µm	200, 275 g/m ²	150, 185 g/m ²	

≠0,50 length max 10 lm
 ≠ 0,70 length max 12 lm

T 50P roof

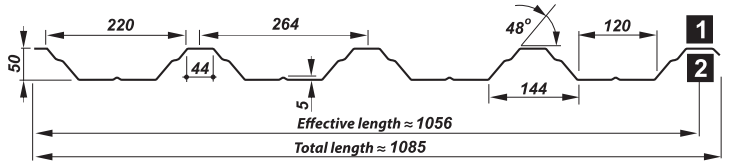
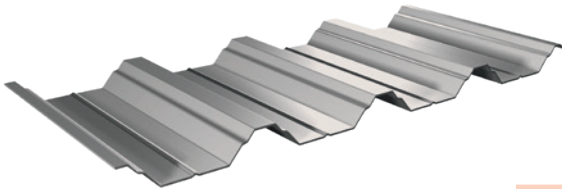

COATING:					STEEL SHEET THICKNESS
polyester		polyurethane	zinc	aluzinc	0,50 mm to 1,25 mm
glossy	matt				
25 µm	35 µm	50 µm	200, 275 g/m ²	150, 185 g/m ²	

≠0,50 length max 10 lm
 ≥ 0,70 length max 12 lm

T 55P roof

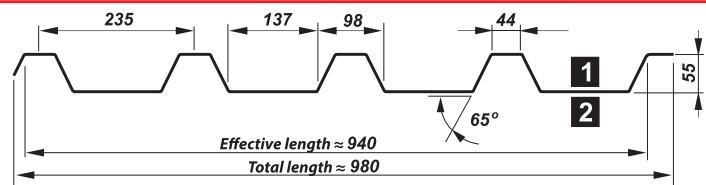
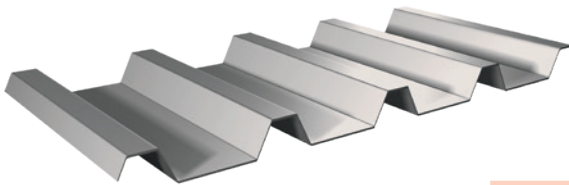

COATING:					STEEL SHEET THICKNESS
polyester		polyurethane	zinc	aluzinc	0,50 mm to 1,25 mm
glossy	matt				
25 µm	35 µm	50 µm	200, 275 g/m ²	150, 185 g/m ²	

≠0,50 length max 10 lm
 ≥ 0,70 length max 12 lm

T 60P roof

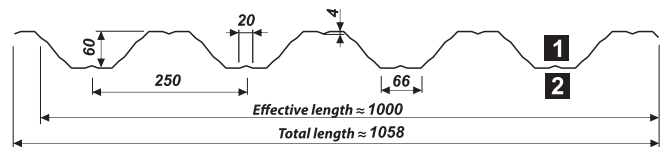
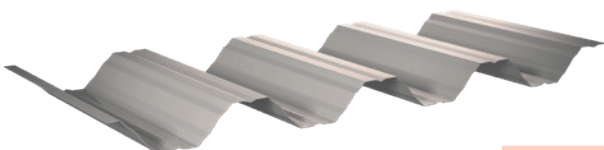

COATING:					STEEL SHEET THICKNESS
polyester		polyurethane	zinc	aluzinc	0,50 mm to 1,25 mm
glossy	matt				
25 µm	35 µm	50 µm	200, 275 g/m ²	150, 185 g/m ²	

≠0,50 length max 10 lm
 ≥ 0,70 length max 12 lm

TRAPEZOIDAL PROFILES

CONSTRUCTION PROFILES

T 50P

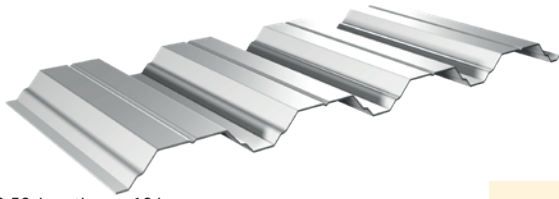

≠0,50 length max 10 lm
≥0,70 length max 12 lm

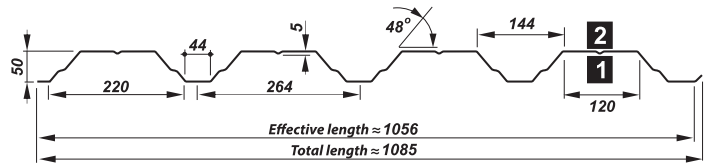

COATING					STEEL SHEET THICKNESS
polyester		polyurethane 50 µm	zinc 200, 275 g/m ²	aluzinc 150, 185 g/m ²	0,50 mm to 1,25 mm
glossy	25 µm				
matt	35 µm				

T 55P

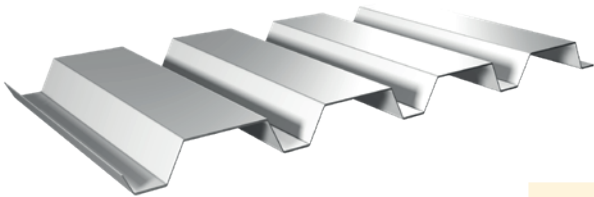

≠0,50 length max 10 lm
≥0,70 length max 12 lm

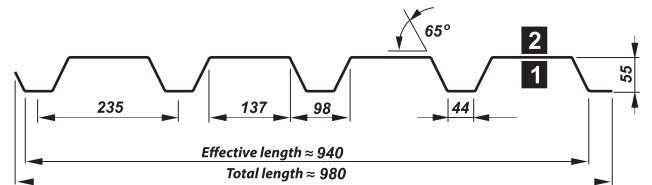

COATING					STEEL SHEET THICKNESS
polyester		polyurethane 50 µm	zinc 200, 275 g/m ²	aluzinc 150, 185 g/m ²	0,50 mm to 1,25 mm
glossy	25 µm				
matt	35 µm				

T 60P



≠0,50 length max 10 lm
≥0,70 length max 12 lm

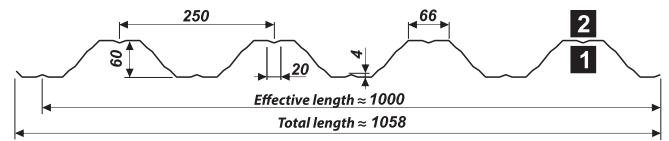

COATING					STEEL SHEET THICKNESS
polyester		polyurethane 50 µm	zinc 200, 275 g/m ²	aluzinc 150, 185 g/m ²	0,50 mm to 1,25 mm
glossy	25 µm				
matt	35 µm				

T 84

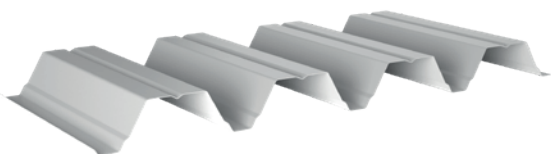

≠0,70 length max 12 lm ≥0,88 length max 14 lm

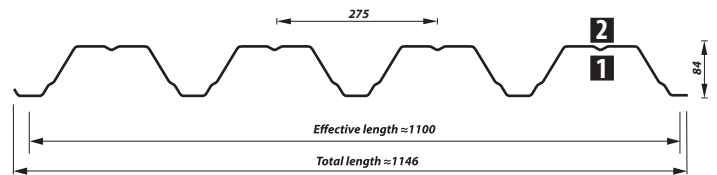

COATING			STEEL SHEET THICKNESS	
polyester glossy	15 and 25 µm	zinc	200, 275 g/m ²	0,70 mm to 1,25 mm

T 92P

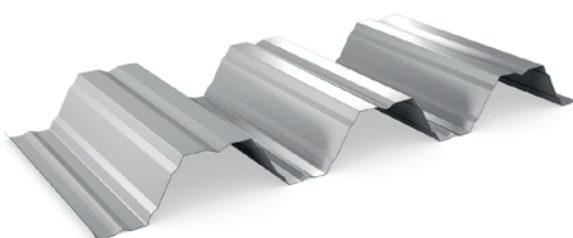

≠0,70 length max 12 lm ≥0,88 length max 14 lm

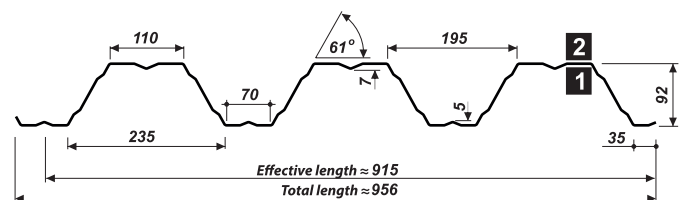

COATING			STEEL SHEET THICKNESS	
polyester glossy	15 and 25 µm	zinc	200, 275 g/m ²	0,70 mm to 1,50 mm

TRAPEZOIDAL PROFILES

T 94



≠0,70 length max 12 lm

≥ 0,88 length max 14 lm

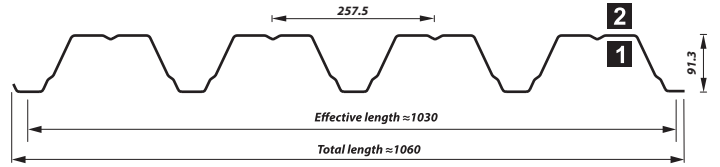

COATING		STEEL SHEET THICKNESS
polyester glossy 15 and 25 µm	zinc 200, 275 g/m ²	0,70 mm to 1,25 mm

T 130

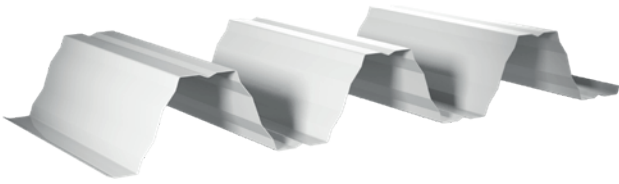

≠0,70 to 1,50 length from 2 lm

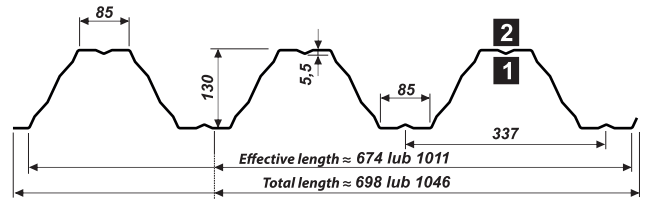

COATING			STEEL SHEET THICKNESS
polyester glossy 15 and 25 µm	zinc 200, 275 g/m ²	aluzinc 150, 185 g/m ²	0,70 mm to 1,50 mm

T 133

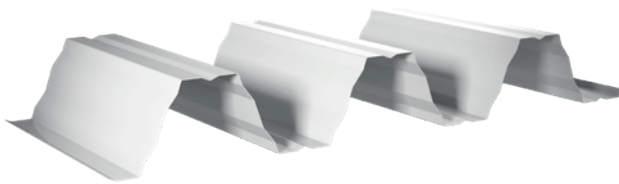

≠0,70 to 1,50 length from 2 lm

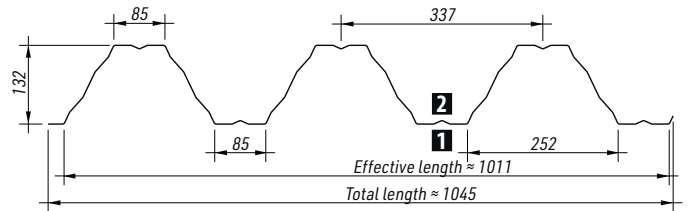

COATING			STEEL SHEET THICKNESS
polyester glossy 15 and 25 µm	zinc 200, 275 g/m ²	aluzinc 150, 185 g/m ²	0,70 mm to 1,50 mm

T 135

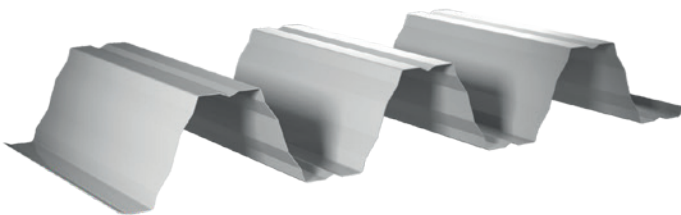

≠0,70 to 1,50 length from 2 lm

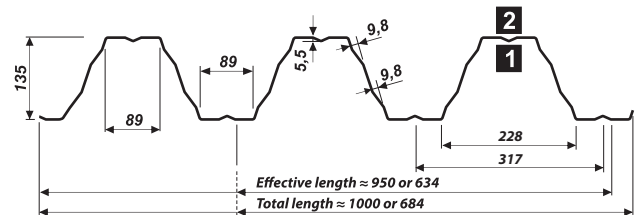

COATING		STEEL SHEET THICKNESS
polyester glossy 15 and 25 µm	zinc 200, 275 g/m ²	0,70 mm to 1,50 mm

T 135P

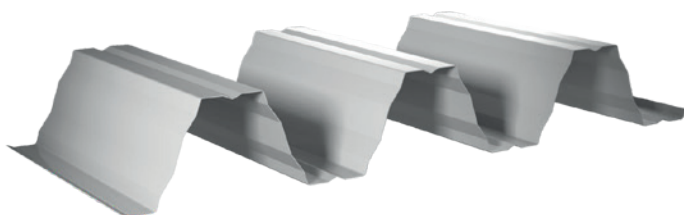

≠0,70 to 1,50 length from 2 lm

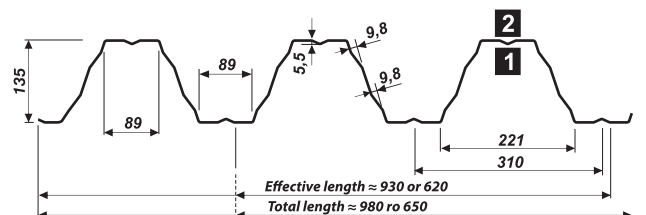

COATING		STEEL SHEET THICKNESS
polyester glossy 15 and 25 µm	zinc 200, 275 g/m ²	0,70 mm to 1,50 mm

TRAPEZOIDAL PROFILES

T 140

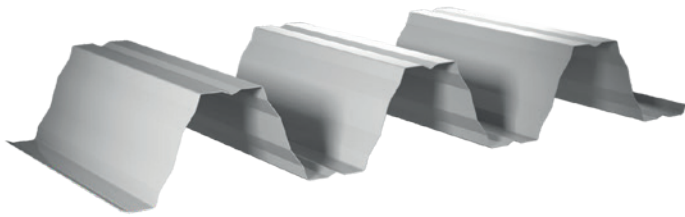

≠0,70 to 1,50 length from 2 lm

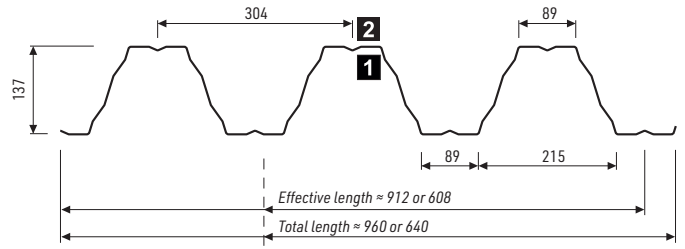

COATING		STEEL SHEET THICKNESS
polyester glossy 15 and 25 µm	zinc 200, 275 g/m ²	0,70 mm to 1,50 mm

T 147

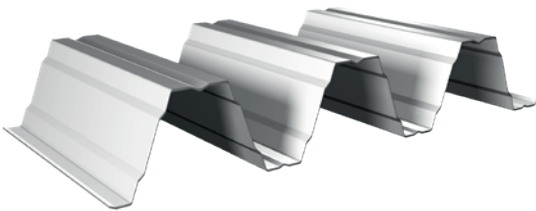

≠0,70 to 1,50 length from 2 lm

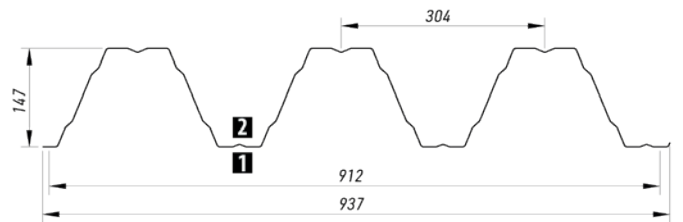

COATING		STEEL SHEET THICKNESS
polyester glossy 15 i 25 µm	zinc 200, 275 g/m ²	0,70 mm to 1,50 mm

T 150

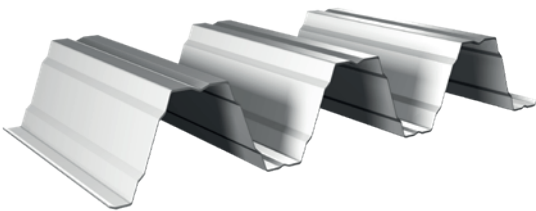

≠0,70 to 1,50 length from 2 lm

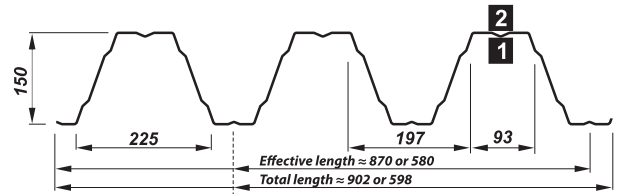

COATING		STEEL SHEET THICKNESS
polyester glossy 15 and 25 µm	zinc 200, 275 g/m ²	0,70 mm to 1,50 mm

T 155

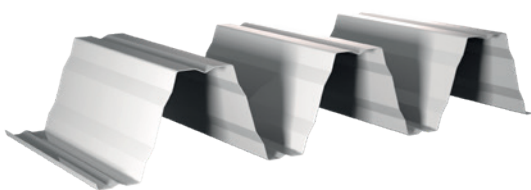

≠0,70 to 1,50 length from 2 lm

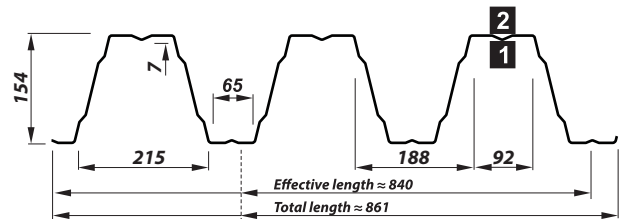

COATING		STEEL SHEET THICKNESS
polyester glossy 15 and 25 µm	zinc 200, 275 g/m ²	0,70 mm to 1,50 mm

T 160

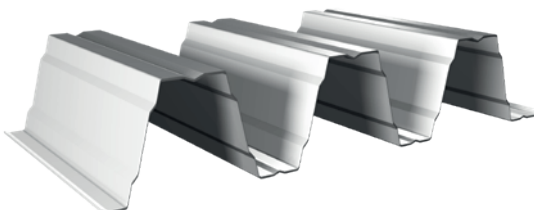

≠0,70 to 1,50 length from 2 lm

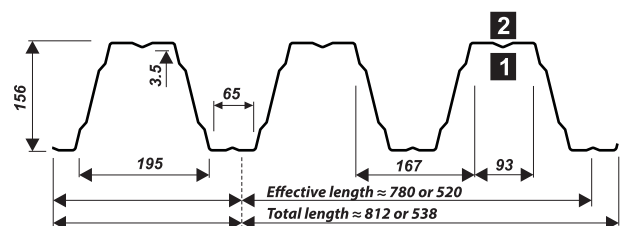

COATING		STEEL SHEET THICKNESS
polyester glossy 15 and 25 µm	zinc 200, 275 g/m ²	0,70 mm to 1,50 mm

TRAPEZOIDAL PROFILES

T 200

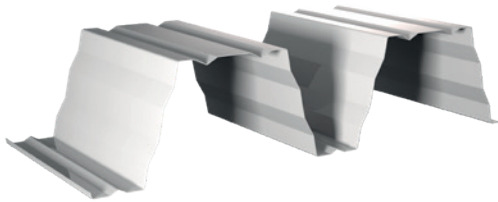

≈0,70 to 1,50 length from 2 lm

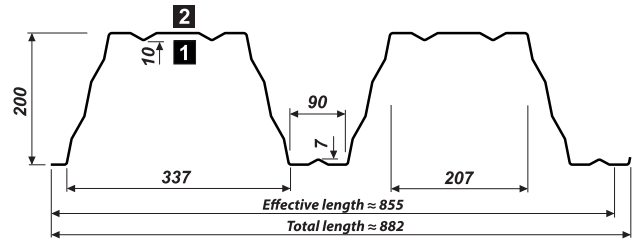

COATING		STEEL SHEET THICKNESS
polyester glossy 15 and 25 µm	zinc 200, 275 g/m ²	0,70 mm to 1,50 mm

ELEVATION PROFILES

T 6 elevation

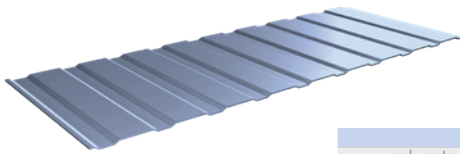

≈0,50 length max 4 lm
≈0,70 length max 6 lm

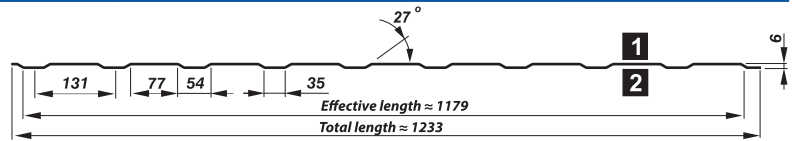

COATING				STEEL SHEET THICKNESS
polyester glossy 25 µm	polyurethane 50 µm	zinc 200, 275 g/m ²	aluzinc 150, 185 g/m ²	0,50 mm to 0,70 mm

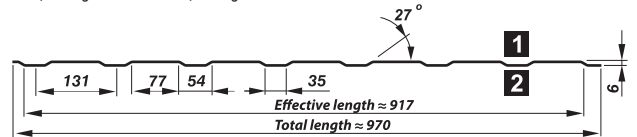

COATING	STEEL SHEET THICKNESS
zinc 200, 275 g/m ²	0,50 mm to 0,70 mm

T 7P elevation

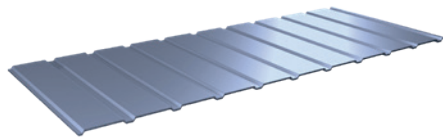

≈0,50 length max 6 lm
≈0,70 length max 6 lm

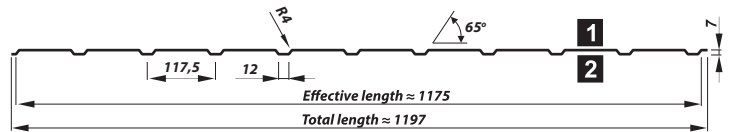

COATING				STEEL SHEET THICKNESS
polyester glossy 25 µm	polyurethane 50 µm	zinc 200, 275 g/m ²	aluzinc 150, 185 g/m ²	0,50 mm to 0,70 mm

T 8 elevation

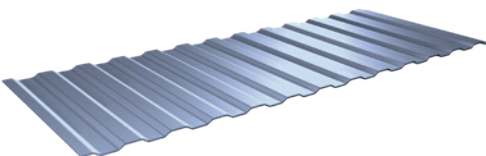

≈0,50 length max 6 lm
≈0,70 length max 6 lm

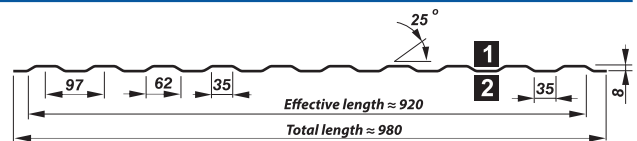

COATING:	STEEL SHEET THICKNESS
zinc 200, 275 g/m ²	0,50 mm to 0,70 mm

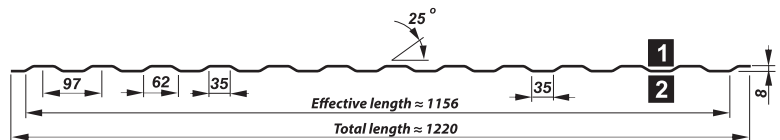

COATING				STEEL SHEET THICKNESS
polyester glossy 25 µm	polyurethane 50 µm	zinc 200, 275 g/m ²	aluzinc 150, 185 g/m ²	0,50 mm to 0,70 mm

T 14 elevation

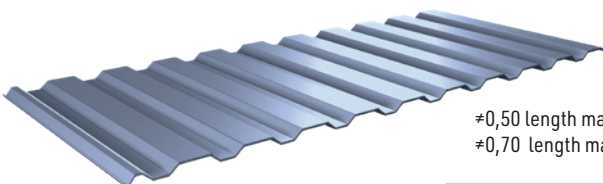

≈0,50 length max 6 lm
≈0,70 length max 7 lm

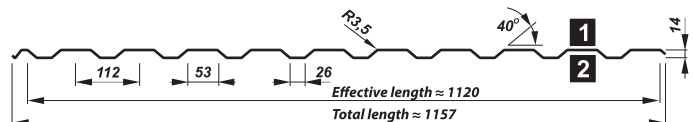

COATING				STEEL SHEET THICKNESS
polyester glossy 25 µm	polyurethane 50 µm	zinc 200, 275 g/m ²	aluzinc 150, 185 g/m ²	0,50 mm to 0,70 mm

T6, T7P, T8 - recommended for smaller surfaces like soffits, garages, garage doors, fences, etc. For more information visit: <https://pruszynski.com.pl/produkt/blachy-trapezowe/trapezy-elewacyjne/t6-elewacja/>

TRAPEZOIDAL PROFILES

T 18 galvanised - elevation

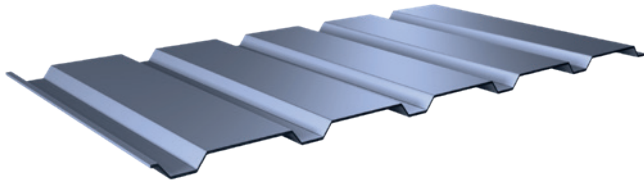

≠0,50 length max 7 lm ≥0,60 length max 8 lm

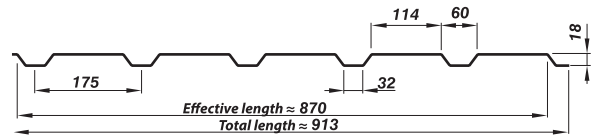

COATING		STEEL SHEET THICKNESS
zinc	200, 275 g/m ²	0,50 mm to 0,80 mm

T 18 DR elevation

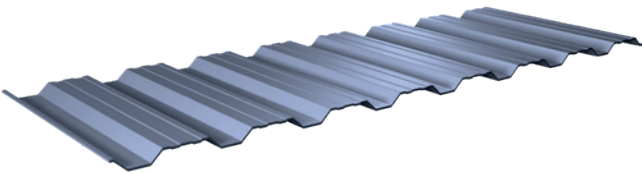

≠0,50 to 0,70 length max 9 lm

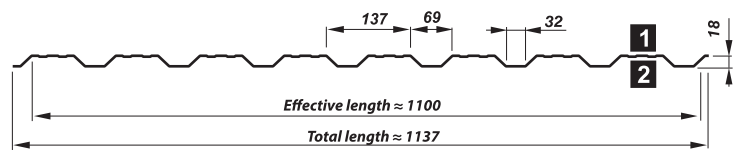

COATING				STEEL SHEET THICKNESS
polyester	polyurethane	zinc	aluzinc	0,50 mm to 0,70 mm
glossy 25 µm	matt 35 µm	50 µm	200, 275 g/m ² 150, 185 g/m ²	

T 18 elevation

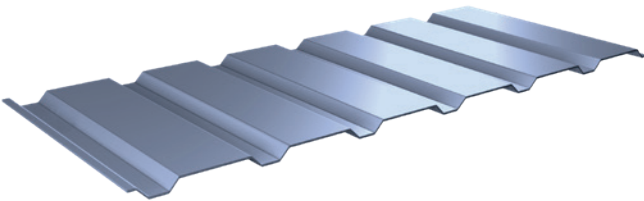

≠0,50 to 0,75 length max 9 lm

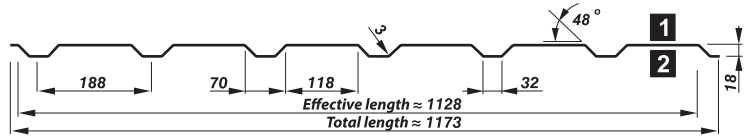

COATING				STEEL SHEET THICKNESS
polyester	polyurethane	zinc	aluzinc	0,50 mm to 0,75 mm
glossy 25 µm	matt 35 µm	50 µm	200, 275 g/m ² 150, 185 g/m ²	

T 18P elevation

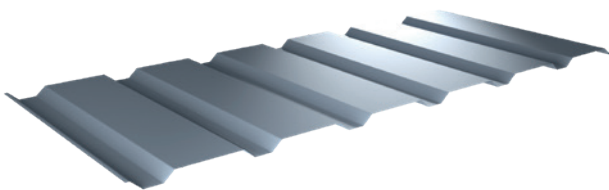

≠0,50 to 0,70 length max 9 lm

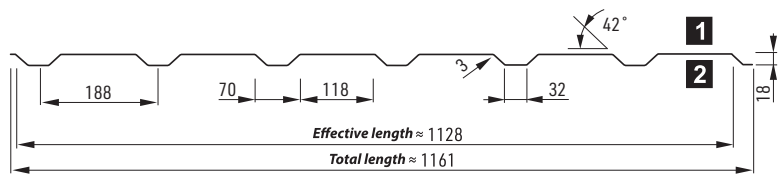

COATING			STEEL SHEET THICKNESS
polyester	polyurethane		0,50 mm to 0,70 mm
glossy 25 µm	matt 35 µm	50 µm	

T 20 elevation

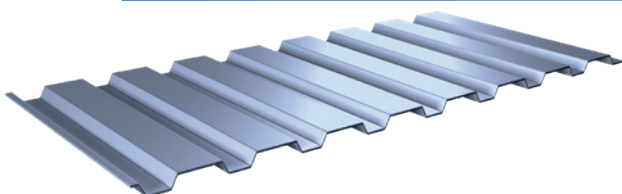

≠0,50 to 0,75 length max 9 lm

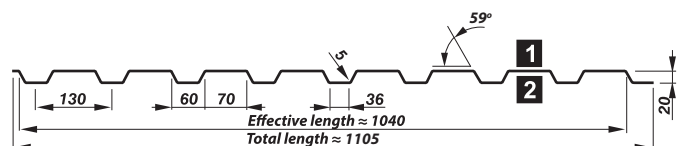

COATING				STEEL SHEET THICKNESS
polyester	polyurethane	aluzinc		0,50 mm to 0,75 mm
glossy 25 µm	matt 35 µm	50 µm	150, 185 g/m ²	

TRAPEZOIDAL PROFILES

T 35E elevation

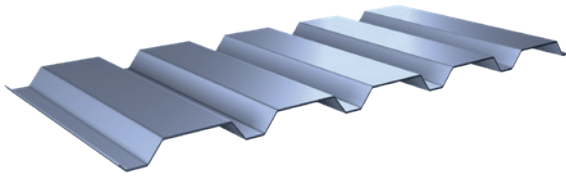

≠0,50 length max 9 lm ≥0,70 length max 12 lm

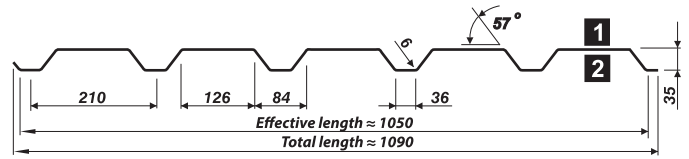

COATING:					STEEL SHEET THICKNESS
polyester		polyurethane	zinc	aluzinc	0,50 mm to 1,00 mm
glossy	matt	50 µm	200, 275 g/m ²	150, 185 g/m ²	
25 µm	35 µm				

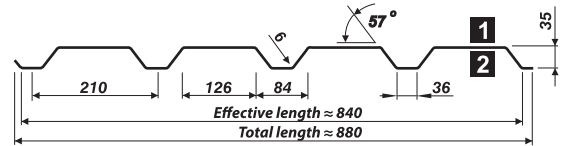

COATING:	STEEL SHEET THICKNESS
zinc	0,50 mm to 1,00 mm
200, 275 g/m ²	

T 35EL elevation

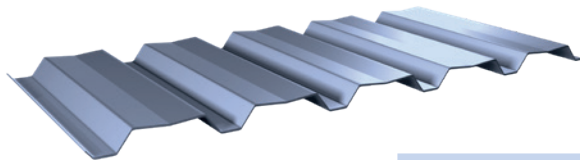

≠0,50 length max 9 lm ≥0,70 length max 12 lm

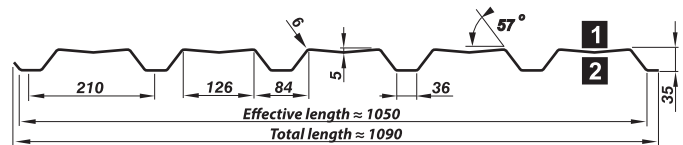

COATING					STEEL SHEET THICKNESS
polyester		polyurethane	zinc	aluzinc	0,50 mm to 1,00 mm
glossy	matt	50 µm	200, 275 g/m ²	150, 185 g/m ²	
25 µm	35 µm				

T 40 elevation

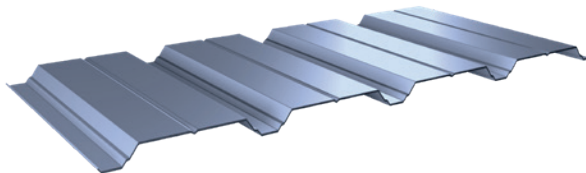

≠0,50 length max 9 lm ≥0,70 length max 12 lm

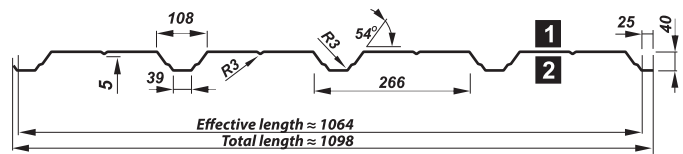

COATING:					STEEL SHEET THICKNESS
polyester		polyurethane	zinc	aluzinc	0,50 mm to 1,0 mm
glossy	matt	50 µm	200, 275 g/m ²	150, 185 g/m ²	
25 µm	35 µm				

T 45 elevation

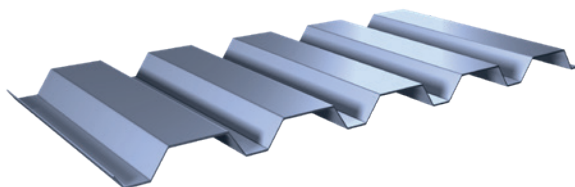

≠0,50 długość max 9 mb ≥0,70 długość max 12 mb

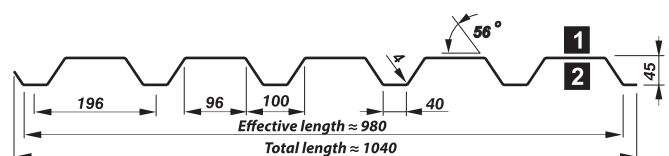

COATING:					STEEL SHEET THICKNESS
polyester		polyurethane	zinc	aluzinc	0,50 mm to 1,0 mm
glossy	matt	50 µm	200, 275 g/m ²	150, 185 g/m ²	
25 µm	35 µm				

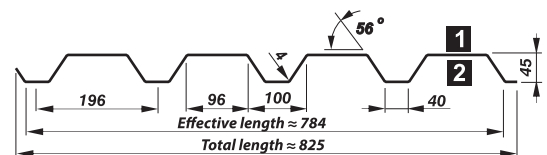

COATING:	STEEL SHEET THICKNESS
zinc	0,50 mm to 1,0 mm
200, 275 g/m ²	

TRAPEZOIDAL PROFILES

T 45P elevation

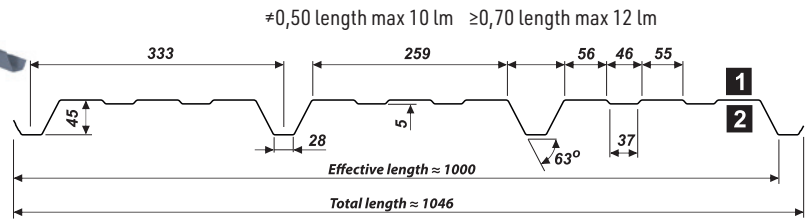
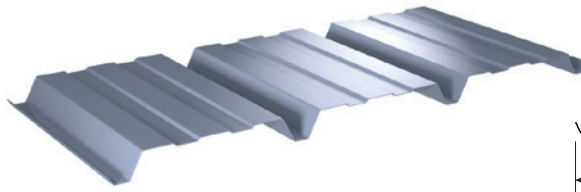

COATING					STEEL SHEET THICKNESS
polyester		polyurethane	zinc	aluzinc	0,50 mm to 1,00 mm
glossy	matt				
25 μm	35 μm	50 μm	200, 275 g/m ²	150, 185 g/m ²	

T 50P elevation

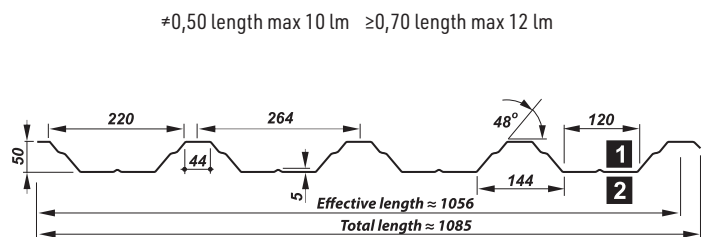
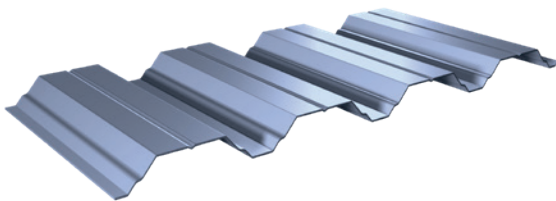

COATING					STEEL SHEET THICKNESS
polyester		polyurethane	zinc	aluzinc	0,50 mm to 1,25 mm
glossy	matt				
25 μm	35 μm	50 μm	200, 275 g/m ²	150, 185 g/m ²	

T 55P elevation

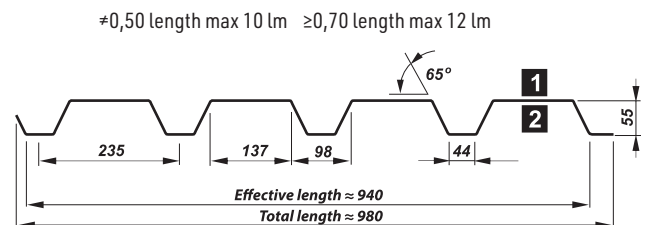
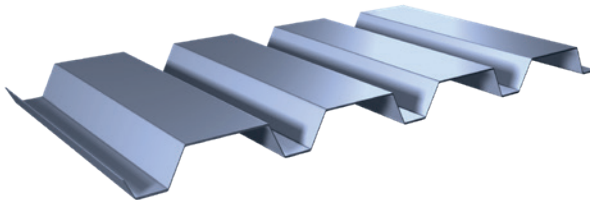

COATING					STEEL SHEET THICKNESS
polyester		polyurethane	zinc	aluzinc	0,50 mm to 1,25 mm
glossy	matt				
25 μm	35 μm	50 μm	200, 275 g/m ²	150, 185 g/m ²	

T 60P elevation

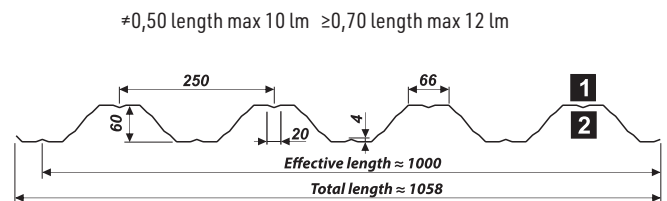
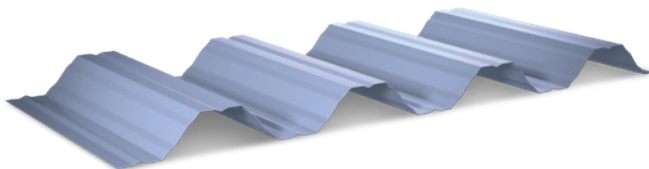

COATING					STEEL SHEET THICKNESS
polyester		polyurethane	zinc	aluzinc	0,50 mm to 1,25 mm
glossy	matt				
25 μm	35 μm	50 μm	200, 275 g/m ²	150, 185 g/m ²	

Our trapezoidal sheets are also available with glued anti-condensation fabric. This is a special membrane that solves the problem of condensation inside buildings with an uninsulated roof. However, we should remember about the natural phenomenon of capillary rise and its negative consequences, which can be avoided by following the installation recommendations.

Details can be found on our website in the **DOWNLOAD** section

<https://pruszynski.com.pl/pobierz/#file-52>

ANTI-CONDENSATION ABSORBER

Anti-condensation fabric is a special membrane that solves the problem of condensation inside buildings with an uninsulated roof. Once the condensation process begins, water drops begin to collect on the underside of the roof. The fabric absorbs approximately 1000 g/m² of water, which accumulates in small gaps in the membrane. When it gets warmer, the water begins to evaporate back into the air and the membrane dries out again.

Technical requirements - what is worth remembering?

When constructing a building with a cold metal roof, general building standards must be followed. Please pay attention to:

- The roof and all its parts must be made, constructed and installed in accordance with applicable construction standards. In this context, ventilation of the panels along the ridge and under the eaves must be ensured. The basic requirement for the proper functioning of the anti-condensate system is good ventilation of the sheets, which should be blown with air in areas created for this purpose - with inlets and outlets.
- When covering newly constructed buildings where water from fresh concreting or plaster is still evaporating, additional ventilation should be provided. Due to the very high relative humidity, dripping is possible. It's normal.
- If a building is constructed during negative temperatures, when it warms up, an additional source of moisture is created. This may cause dripping. To prevent this, it is necessary that the roof panels are thoroughly dried before installation or that there is adequate ventilation after installation.
- If possible, try to ensure that the temperature in the building does not drop to 0°C. If frost occurs throughout the building, the heating method is important. In this case, faster heating helps to reduce possible dripping.

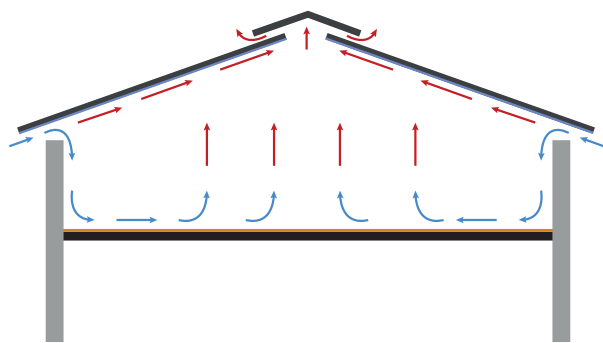

Adequate ventilation in an insulated building with air inflow on the sides and air outflow through the roof ridge.

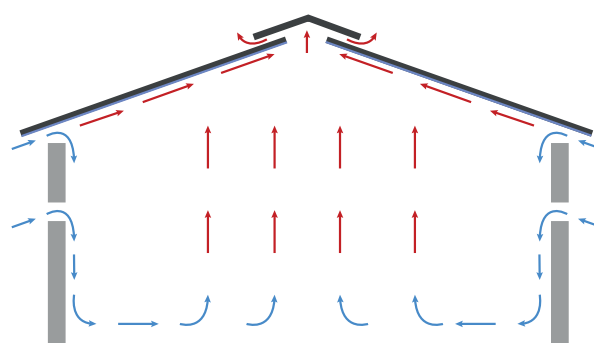

Adequate ventilation in an uninsulated building with air inflow on the sides and air outflow through the roof ridge.

- Possible capillary rise must be prevented in areas where the layers of material overlap (less than 200 mm) and on eave. On single-pitched roofs, capillary rising at the eaves and ridge should be prevented. This can be done with a gas or electric torch or similar tool.
- Do not expose edges of the absorber to direct sunlight or other weather conditions (strong wind, rain). It also applies to the storage of the material.
- Do not damage surface of the fabric.
- When installing the roof, the roof panels must be dry on the side with the absorber.

Capillary rise

Anti-condensation fabric tolerates capillary action much better and allows it to be easily controlled. Capillary rise is a natural feature of every anti-condensation membrane. However, this phenomenon should not be too strong because it may also have negative consequences.

The diagram below shows what the absorber looks like:

- A - without preventing capillary rise
- B - to prevent capillary action

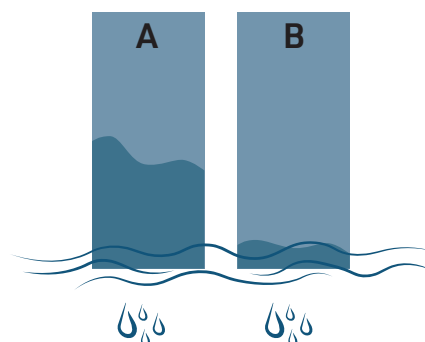

ATTENTION!

Details on how to prevent capillary rise can be found on our website in the - DOWNLOAD section
<https://pruszynski.com.pl/pobierz/#file-52>

CORRUGATED ELEVATION PROFILES, WALL PANELS PS

PF 25

Corrugated elevation profiles combine modern shape and technology with traditional for Blachy Pruszyński solicitude to the highest quality. They are applied in the same way as trapezoidal profiles - for the construction of houses, offices and administrative buildings, warehouses, sports halls, as well as in all cases where not only the aesthetics, but also uniqueness and innovative shape are important. They excellently emphasize the object originality which is currently as substantial as functionality and life time. The Blachy Pruszyński offers profile PF25 with slight wave that serves as an excellent profile for smaller buildings and as a decorative element.

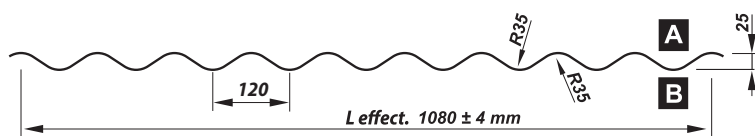
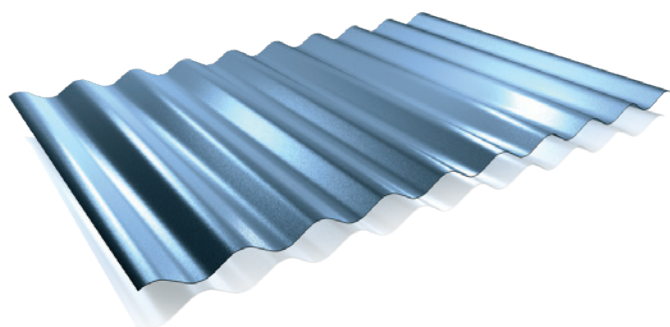

NOTE: The profiles are suitable for elevation when:
A is coated with decorative coating,
B is coated with protective coating (primer)

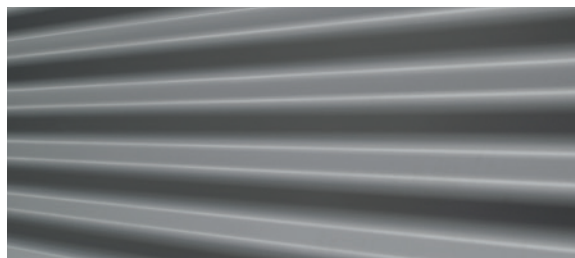

Profile height [mm]	25
Core width [mm]	1250
Effective width [mm]	1080
Total width [mm]	1114
Max. Sheet length [mb]	6 / 7
Min. sheet length [mb]	0,5
Thickness [mm]	0,5 / 0,7
Perforation	yes
Accessories	screws, nails, anti-condensation film

Panel

Wall panels PS are outstanding product for cladding of the walls and facades of industrial and service buildings, supermarkets and warehouses. It fulfils protective and aesthetic goals.



thickness - 0,5; 0,7 mm

Width - 155; 215; 315 mm (panels with width 315 mm are available only in thickness 0,7 mm)

Colour - see: page 51

Coating - glossy polyester, matt polyurethane, BLACKMAT

length - Panels can have any length between:
 for thickness 0,7 mm - 1 - 8 m
 for thickness 0,5 mm - 1 - 6 m

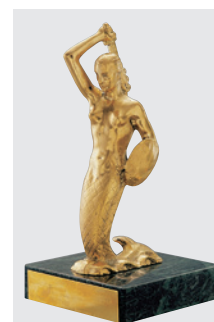
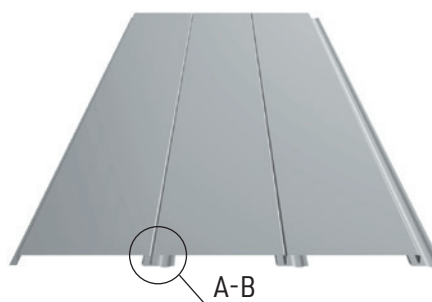
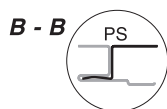
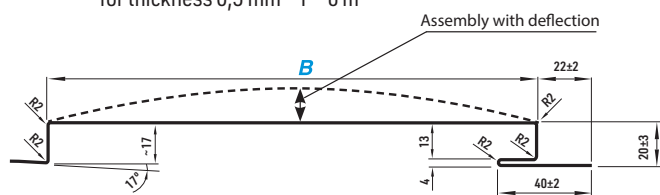

ZŁOTA SYRENKA
 Honorary award
 granted at Warsaw
 Building Industry Fairs
 for WALL PANELS,
 a product displaying
 high technical and
 usable qualities

B - total width

PS: 155 / 215 / 315

ALL PRODUCTS HOLD ITB (BUILDING RESEARCH INSTITUTE) AND PZH (NATIONAL INSTITUTE OF HYGIENE) CERTIFICATES

WALL SANDWICH PANELS WITH MINERAL WOOL

PWS2-MW-ST

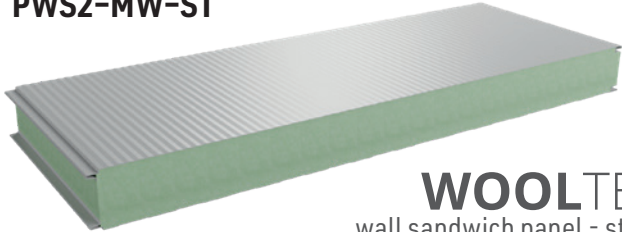

WOOLTECH wall sandwich panel - standard

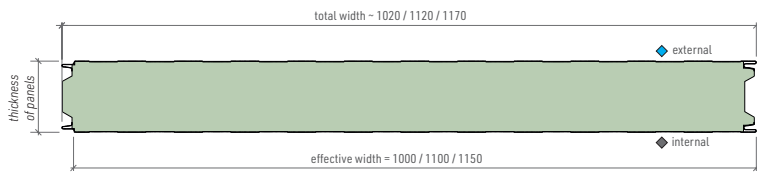

core [kg/m ³]	ST - Mineral wool with density of 115
thickness of panels [mm]	60, 80, 100, 120, 140, 150, 160, 180, 200, 220, 240
effective width [mm]	1000, 1100*, 1150
total width [mm]	1020, 1120, 1170
minimal length of panel [lm]	2,0
maximum length of panel [lm]	16 (depending on the colour)**
thickness of steel sheets ext./int. [mm]	0,5 - 0,7
type of external profile	trapezoidal - T micro-trapezoidal - M wave - F nanowave - N flat - P***
type of internal profile	trapezoidal - T, flat - P***
coverings	polyester glossy, polyurethane, PMG35* Colorcoat HPS200 Ultra®
accessories	fastening elements, seals, flashings

PWS2-MW-PL

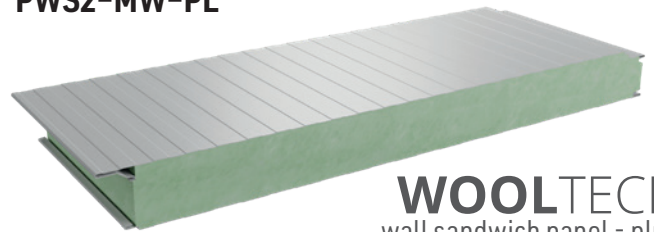

WOOLTECH wall sandwich panel - plus

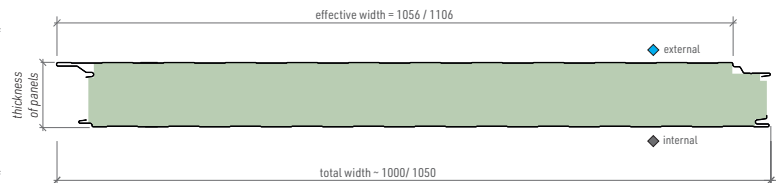

core [kg/m ³]	Mineral wool with density of 115
thickness of panels [mm]	100, 120, 150, 200
effective width [mm]	1056, 1106
total width [mm]	1000, 1050
minimal length of panel [lm]	2,0
maximum length of panel [lm]	16 (depending on the colour)**
thickness of steel sheets ext./int. [mm]	0,5 - 0,7
type of external profile	trapezoidal - T micro-trapezoidal - M wave - F nanowave - N flat - P**
type of internal profile	trapez - T, płaska - P***
coverings	polyester glossy, polyurethane, PMG35* Colorcoat HPS200 Ultra®
accessories	fastening elements, seals, flashings

PWS2-MW-ST panels are additionally available in the following versions:

- PWS2-MW-ST SAFETY in thicknesses of 200 and 240 mm
- PWS2-MW-ST THERMO in thicknesses of 180 and 200 mm

[More information on our website!](#)

JOINT LOCK FOR PANELS PWS2-MW-ST

core thickness	60, 80, 100	120, 140, 150, 160, 180	200, 220, 240
joint lock			

JOINT LOCK FOR PANELS PWS2-MW-PL

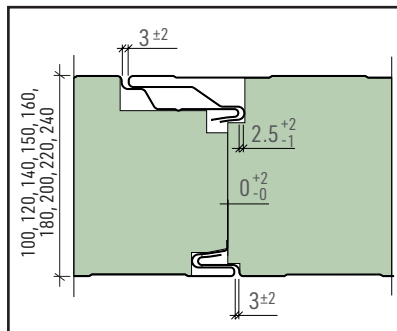

STRAIN DISTRIBUTOR

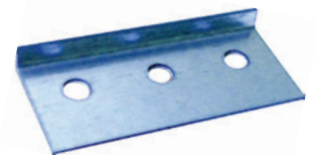

Strain Distributor is a necessary element during assembly of sandwich panels with hidden joint PWS2-MW-PL. Its exclusion decreases lifting capacity about 30%. Three holes in strain distributor help placing the joints towards the construction. It was established to use two joints on each element.

*ask for availability, depends on the order quantity and size

**Maximum permitted length of panel may vary depending on the colour of its external cladding. When exposed to sunlight, external steel cladding is absorbing the temperature. The darker the colour is, the stronger is the absorption. Due to amplitude of temperature (Δt) between external and internal cladding, a thermal tensility occurs which affects work of sandwich panel fixed to the construction of the building. This tensility may cause creasing of surface of the panel or, in extreme cases, damage of the panel on intermediate supports. Purchase orders for panels longer than recommended in particular colour may be accepted only after customer's written statement confirming ones awareness of the risk of damage and consent to manufacturing under such risk. Limitation of maximum length of PIRTECH and WOOLTECH panels are specified on our website: www.pruszyński.com.pl

***flat profilation is available only for thickness $\geq 0,6$ mm

WALL SANDWICH PANELS WITH MINERAL WOOL

PWS2-MWA-ST

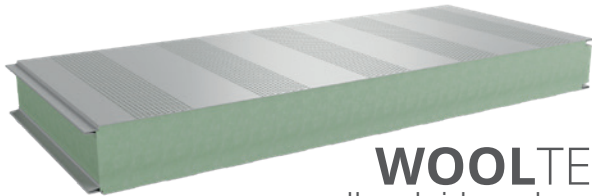

WOOLTECH wall sandwich panel - acoustic

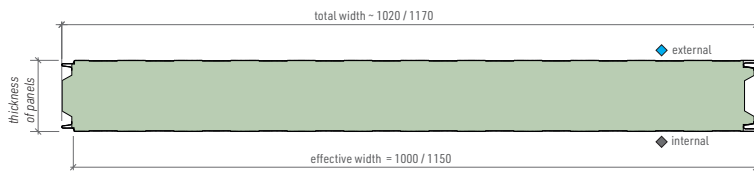

core [kg/m³]	Mineral wool with density of 115
thickness of panels [mm]	60, 80, 100, 120, 140, 150, 160, 180, 200, 220, 240
effective width [mm]	1000, 1150
total width [mm]	1020, 1170
minimal length of panel [lm]	2,0
maximum length of panel [lm]	16 (depending on the colour)**
thickness of steel sheets ext./int. [mm]	0,5 - 0,7
type of external profile	trapezoidal - T micro-trapezoidal - M wave - F nanowave - N flat - P***
type of internal profile	flat - P***
coverings	polyester glossy, polyurethane, PMG35* Colorcoat HPS200 Ultra®
accessories	fastening elements, seals, flashings

PWD2-MW

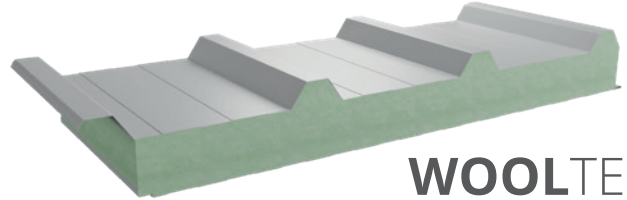

WOOLTECH roof sandwich panels

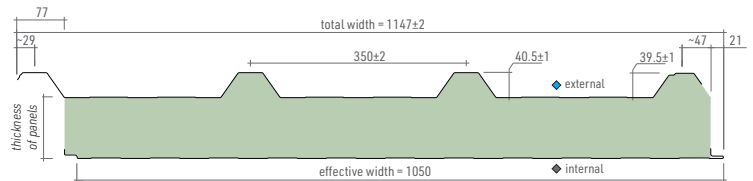

core [kg/m³]	Mineral wool with density of 115
thickness of panels [mm]	100, 120, 150, 160, 200, 240, 250
effective width [mm]	1050
total width [mm]	1147±2
minimal length of panel [lm]	2,0
maximum length of panel [lm]	16 (depending on the colour)**
thickness of steel sheets ext./int. [mm]	0,5 - 0,7
type of external profile	trapezoidal T40
type of internal profile	trapezoidal - T, flat - P***
coverings	polyester glossy, polyurethane, PMG35* Colorcoat HPS200 Ultra®
accessories	fastening elements, seals, flashings

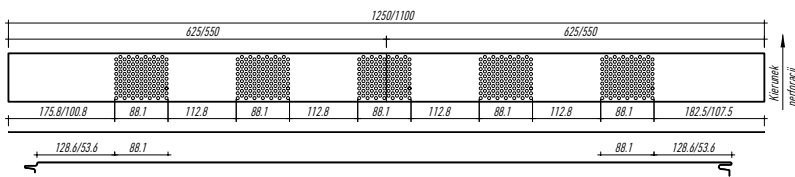

JOINT LOCK FOR PANELS PWD2-MW

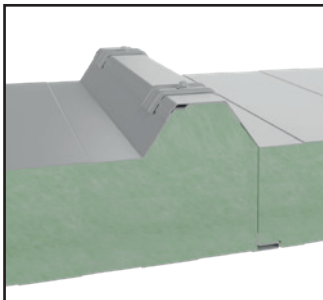

CALOTTE

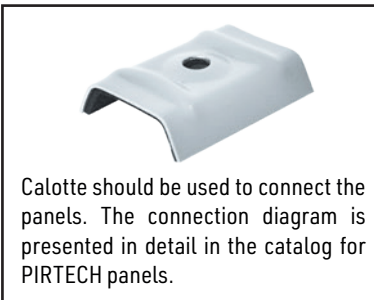

PROFILATION OPTIONS

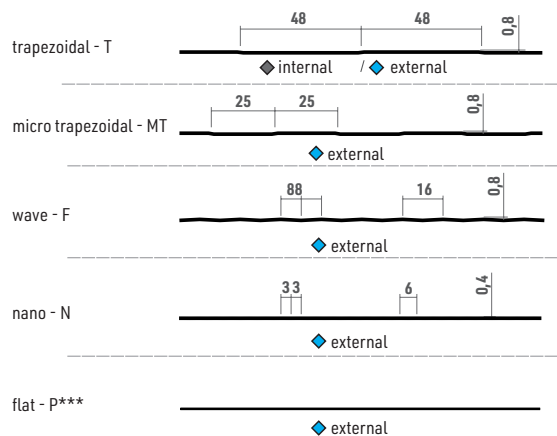

TOP BUILDER 2023

Wall and roof sandwich panels with metal cladding and a mineral wool core.

Award for top-quality products: innovations and novelties, including proven material, technological, and structural solutions.

The offer also includes coatings for internal steel sheets which may be used in a chemically aggressive environment.

see page s. 50

SANDWICH PANELS WITH POLYURETHANE CORE PIRTECH



PWS-PIR-ST

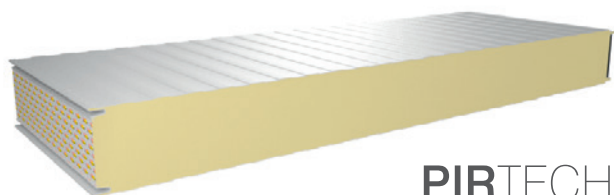

PIRTECH
wall sandwich panel - standard

cross section

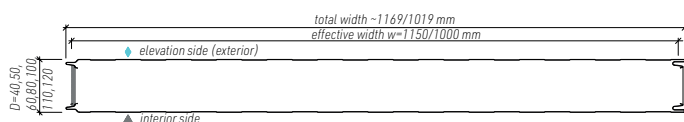

core	polyurethane PIR
thickness of panels [mm]	40, 50*, 60, 80, 100, 110, 120
effective width [mm]	1000, 1100, 1150
total width [mm]	1020, 1120, 1170
minimal length of panel [lm]	2,0
maximum length of panel [lm]	18**
thickness of steel sheets ext./int. [mm]	0,5/0,4 0,4 - 0,7 / 0,4 - 0,63 for order
Lambda ratio [W/mK]	0,022
type of external profile	trapezoidal - T micro-trapezoidal - MT wave - F cassette - K flat - P
type of internal profile	trapezoidal - T
coverings	polyester glossy, polyurethane, PMG35* Colorcoat HPS200 Ultra®
accessories	fastening elements, seals, flashings

PWS-PIR-PL

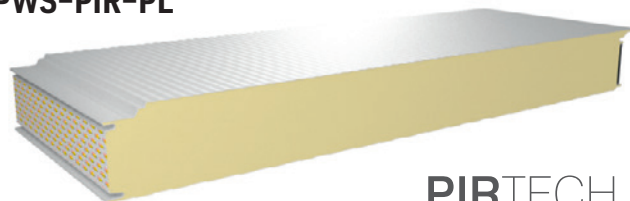

PIRTECH
wall sandwich panels PLUS

cross section

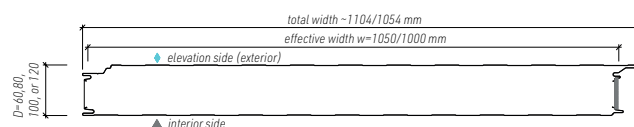

core	poliuretan PIR
thickness of panels [mm]	60, 80, 100, 120
effective width [mm]	1000, 1050
total width [mm]	1054, 1104
minimal length of panel [lm]	2,0
maximum length of panel [lm]	18**
thickness of steel sheets ext./int. [mm]	0,5/0,4 0,4 - 0,7 / 0,4 - 0,63 for order
Lambda ratio [W/mK]	0,022
type of external profile	trapezoidal - T micro-trapezoidal - MT wave - F cassette - K
type of internal profile	trapezoidal - T
coverings	polyester glossy, polyurethane, PMG35* Colorcoat HPS200 Ultra®
accessories	fastening elements, seals, flashings

type of profiles:



Micro trapezoidal profile is available only for external claddings

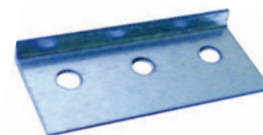

STRESS DISTRIBUTOR

Stress distributor is necessary element used during assembly of PIRTECH PLUS Sandwich Panels with hidden joint. Not using it can lead to decrease of carrying capacity of panels for 30%. Three holes help placing the joints towards the construction.

* ask for availability

** Maximum permitted length of panel may vary depending on the colour of its external cladding. When exposed to sunlight, external steel cladding is absorbing the temperature. The darker the colour is, the stronger is the absorption. Due to amplitude of temperature (Δt) between external and internal cladding, a thermal tensility occurs which affects work of sandwich panel fixed to the construction of the building. This tensility may cause creasing of surface of the panel or, in extreme cases, damage of the panel on intermediate supports. Purchase orders for panels longer than recommended in particular colour may be accepted only after customer's written statement confirming ones awareness of the risk of damage and consent to manufacturing under such risk. Limitation of maximum length of PIRTECH and WOOLTECH panels are specified on our website: www.pruszynski.com.pl

SANDWICH PANELS WITH POLYURETHANE CORE PIRTECH

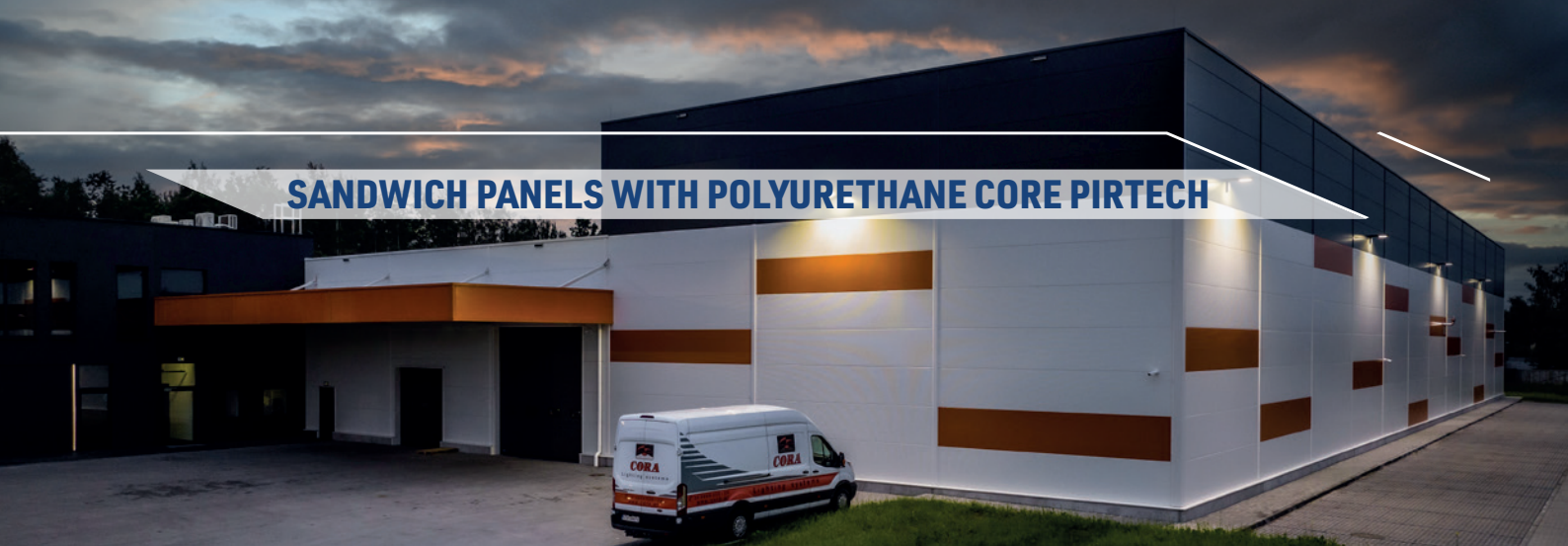

PWS-PIR-CH

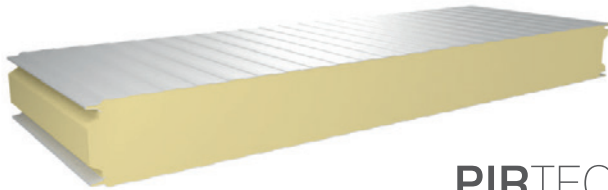

PIRTECH
cold storage sandwich panels

cross section

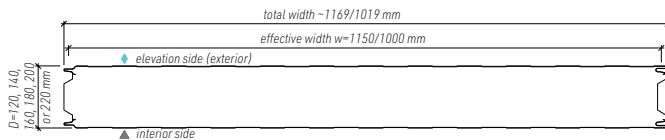

core	poliuretan PIR
thickness of panels [mm]	120, 140, 160, 180, 200, 220
effective width [mm]	1000, 1100, 1150
total width [mm]	1020, 1120, 1170
minimal length of panel [lm]	2,0
maximum length of panel [lm]	18**
thickness of steel sheets ext./int. [mm]	0,5/0,4 0,4 - 0,7 / 0,4 - 0,63 for order
Lambda ratio [W/mK]	0,022
type of external profile	trapezoidal - T micro-trapezoidal - MT wave - F cassette - K
type of internal profile	trapezoidal - T
coverings	polyester glossy, polyurethane, PMG35* Colorcoat HPS200 Ultra®
accessories	fastening elements, seals, flashings

PWD-PIR

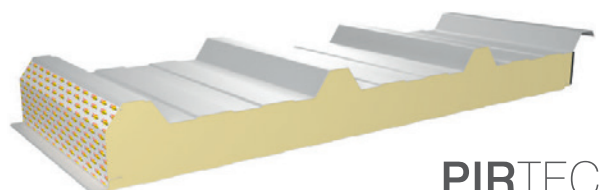

PIRTECH
roof sandwich panels

cross section

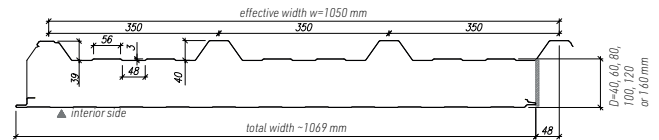

core	poliuretan PIR
thickness of panels [mm]	40, 60, 80, 100, 120, 160
effective width [mm]	1050
total width [mm]	1070
minimal length of panel [lm]	2,0
maximum length of panel [lm]	18**
thickness of steel sheets ext./int. [mm]	0,5/0,4 0,4 - 0,7 / 0,4 - 0,63 for order
Lambda ratio [W/mK]	0,022
type of external profile	trapezoidal T40
type of internal profile	trapezoidal - T
coverings	polyester glossy, polyurethane, PMG35* Colorcoat HPS200 Ultra®
accessories	fastening elements, seals, flashings

The offer also includes coatings for internal steel sheets that are used in a chemically aggressive environment - see page 50

Types of PIRTECH panels

	STANDARD -ST	PLUS -PL	COLD STORAGE -CH	ROOF
name				
signature	PWS-PIR-ST	PWS-PIR-PL	PWS-PIR-CH	PWD-PIR
lock				

CALOTTE



Calotte should be used to connect the panels. The connection diagram is presented in detail in the catalog for PIRTECH panels.



EUROPEAN MEDAL 2017 for wall and roof sandwich panels PIRTECH

Prize awarded by European Affairs Committee, Business Centre Club and European Committee Economical - Social for products and services presenting European quality

PROFILES Z, C, Σ

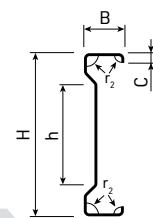
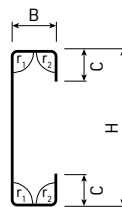
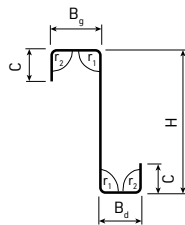

„Z” profiles

	Sheet thickness mm	weight kg/m	H mm	Bd mm	Bg mm	C mm
Z 100	1,50	2,64	100	48	53	16
	2,00	3,52	100	48	53	16
	2,50	4,40	100	48	55	16
	3,00	5,28	100	48	55	16
	3,50*	6,16	100	47	56	16
Z 100	1,50	3,00	100	60	68	16
	2,00	4,00	100	60	68	16
	2,50	5,00	100	60	68	16
	3,00	6,00	100	60	68	16
	3,50*	7,00	100	60	68	16
Z 150	1,50	3,24	150	48	53	21
	2,00	4,32	150	48	53	21
	2,50	5,40	150	48	55	21
	3,00	6,48	150	48	55	21
	3,50*	7,56	150	47	56	21
Z 150	1,50	3,60	150	60	68	21
	2,00	4,80	150	60	68	21
	2,50	6,00	150	60	68	21
	3,00	7,20	150	60	68	21
	3,50*	8,40	150	60	68	21
Z 180	1,50	3,96	180	60	68	21
	2,00	5,28	180	60	68	21
	2,50	6,60	180	60	68	21
	3,00	7,92	180	60	68	21
	3,50*	9,24	180	60	68	21
Z 200	1,50	3,84	200	48	53	21
	2,00	5,12	200	48	53	21
	2,50	6,40	200	48	55	21
	3,00	7,68	200	48	55	21
	3,50*	9,96	200	47	56	21
Z 200	1,50	4,20	200	60	68	21
	2,00	5,60	200	60	68	21
	2,50	7,00	200	60	68	21
	3,00	8,40	200	60	68	21
	3,50*	9,80	200	60	68	21
Z 250	1,50	4,80	250	60	68	21
	2,00	6,40	250	60	68	21
	2,50	8,00	250	60	68	21
	3,00	9,60	250	60	68	21
	3,50*	11,20	250	60	68	21
Z 250	1,50	4,97	250	65	75	21
	2,00	6,62	250	65	75	21
	2,50	8,24	250	65	75	21
	3,00	9,89	250	65	75	21
	3,50*	11,54	250	65	75	21
Z 300	1,50	5,69	300	65	75	21
	2,00	7,58	300	65	75	21
	2,50	9,32	300	65	75	21
	3,00	11,18	300	65	75	21
	3,50*	13,04	300	65	75	21
Z 350	1,50	6,24	350	65	75	21
	2,00	8,32	350	65	75	21
	2,50	10,40	350	65	75	21
	3,00	12,48	350	65	75	21
	3,50*	14,56	350	65	75	21
Z 400	1,50	6,79	400	65	75	21
	2,00	9,06	400	65	75	21
	2,50	11,32	400	65	75	21
	3,00	13,58	400	65	75	21
	3,50*	15,84	400	65	75	21
Z 350	1,50	6,48	350	75	85	21
	2,00	8,64	350	75	85	21
	2,50	10,80	350	75	85	21
	3,00	12,96	350	75	85	21
	3,50*	15,20	350	75	85	21
Z 400	1,50	7,08	400	75	85	21
	2,00	9,44	400	75	85	21
	2,50	11,80	400	75	85	21
	3,00	14,16	400	75	85	21
	3,50*	16,52	400	75	85	21

„C” profiles

	Sheet thickness mm	weight kg/m	H mm	B mm	C mm
C 100	1,50	2,64	100	48	16
	2,00	3,52	100	48	16
	2,50	4,36	100	48	16
	3,00	5,23	100	48	16
	3,50*	6,10	100	48	16
C 100	1,50	2,88	100	60	16
	2,00	3,84	100	60	16
	2,50	4,76	100	60	16
	3,00	5,71	100	60	16
	3,50*	6,66	100	60	16
C 150	1,50	3,24	150	48	21
	2,00	4,32	150	48	21
	2,50	5,36	150	48	21
	3,00	6,43	150	48	21
	3,50*	7,50	150	48	21
C 150	1,50	3,60	150	60	21
	2,00	4,80	150	60	21
	2,50	5,96	150	60	21
	3,00	7,15	150	60	21
	3,50*	8,34	150	60	21
C 200	1,50	3,84	200	48	21
	2,00	5,12	200	48	21
	2,50	6,36	200	48	21
	3,00	7,63	200	48	21
	3,50*	8,90	200	48	21
C 200	1,50	4,20	200	60	21
	2,00	5,60	200	60	21
	2,50	6,96	200	60	21
	3,00	8,35	200	60	21
	3,50*	9,74	200	60	21
C 250	1,50	4,50	250	48	21
	2,00	6,00	250	48	21
	2,50	7,40	250	48	21
	3,00	8,88	250	48	21
	3,50*	10,36	250	48	21
C 250	1,50	4,80	250	60	21
	2,00	6,40	250	60	21
	2,50	7,96	250	60	21
	3,00	9,55	250	60	21
	3,50*	11,14	250	60	21
C 300	1,50	5,02	300	48	21
	2,00	6,69	300	48	21
	2,50	8,28	300	48	21
	3,00	9,94	300	48	21
	3,50*	11,60	300	48	21
C 300	1,50	5,33	300	60	21
	2,00	7,10	300	60	21
	2,50	8,72	300	60	21
	3,00	10,46	300	60	21
	3,50*	12,20	300	60	21
C 350	1,50	6,26	350	75	21
	2,00	8,35	350	75	21
	2,50	10,40	350	75	21
	3,00	12,48	350	75	21
	3,50*	14,56	350	75	21
C 400	2,50	11,32	400	75	21
	3,00	13,58	400	75	21
	3,50*	15,84	400	75	21

„Σ” profiles

	Sheet thickness mm	weight kg/m	H mm	h mm	B mm	C mm
Σ 140	1,50	3,84	140	30	70	16
	2,00	5,12	140	30	70	16
	2,50	6,24	140	30	70	16
	3,00	7,49	140	30	70	16
	3,50*	8,74	140	30	70	16
Σ 170	1,50	4,20	170	60	70	16
	2,00	5,60	170	60	70	16
	2,50	6,84	170	60	70	16
	3,00	8,21	170	60	70	16
	3,50*	9,58	170	60	70	16
Σ 200	1,50	4,56	200	90	70	16
	2,00	6,08	200	90	70	16
	2,50	7,44	200	90	70	16
	3,00	8,93	200	90	70	16
	3,50*	10,42	200	90	70	16
Σ 230	1,50	4,96	230	120	70	16
	2,00	6,56	230	120	70	16
	2,50	8,04	230	120	70	16
	3,00	9,65	230	120	70	16
	3,50*	11,26	230	120	70	16
Σ 260	1,50	5,28	260	150	70	16
	2,00	7,04	260	150	70	16
	2,50	8,64	260	150	70	16
	3,00	10,37	260	150	70	16
	3,50*	12,00	260	150	70	16
Σ 300	1,50	5,76	300	190	70	16
	2,00	7,68	300	190	70	16
	2,50	9,44	300	190	70	16
	3,00	11,33	300	190	70	16
	3,50*	13,22	300	190	70	16
Σ 350	1,50	6,36	350	240	70	16
	2,00	8,48	350	240	70	16
	2,50	10,44	350	240	70	16
	3,00	12,53	350	240	70	16
	3,50*	14,62	350	240	70	16

Dimensional tolerances of C, Z, Σ profiles

SYMBOL	DEVIATION FROM THE NOMINAL DIMENSION
B, Bg, Bd	± 2 mm
H	± 2 mm
h	± 2 mm
C (16-30 mm)	± 2 mm
r1	± 1°15'
r2	± 1°45'

Dimension C for Z and C profiles can be made in lengths from 16 to 30 mm. The exceptions are profiles with a height of H = 100 and the Σ profile - in this case C dimension is invariably 16 mm.

- any changes available after prior arrangement with the production department.

*Thickness 3,5 mm is available only for special orders, for more details please contact with our sale representatives. Details after consultation with the sales or technical department.

BLACHY PRUSZYŃSKI

Aplikacje

Wybierz profil i kolor, a program automatycznie wyliczy wagę, długość i liczbę profili. Wygeneruj kod QR, który możesz przesłać klientowi. Wygeneruj kod QR, który możesz przesłać klientowi.

[[0]] Adresz adres profilu C i Sigma

[[0]] Adresz adres koloru

[[0]] Adresz adres koloru

[[0]] Adresz adres koloru

<https://pruszynski.com/pl/pobierz/#file-55>

THIS IS THE PROGRAM FOR SELECTION OF THIN-WALLED PURLINS



Profiles U, C+, Σ+

Blachy Pruszyński company launched new production line for cold-bended profiles with new additional profiles: U, C+, Σ+. What's more, new line is equipped in laser cut, which enables made of different cuts, excisions in any part of profile and bends under purlin bracings - any changes available after prior arrangement with the production department.

Openings

Profiles U, C+, Σ+ can be made with assembly holes (Ø 10 mm, Ø 12 mm, Ø 14 mm, Ø 16 mm, Ø 18 mm, Ø 22 mm, bean 14x18 mm, 14x25 mm, 19x25 mm).

Material

Galvanised steel tape (S350GD or S390GD) with magnelis coating ZM 120 in thickness from 1,5 to 3,5 mm. Due to use and needs, profiles don't need any additional protection, but they can be powder painted.

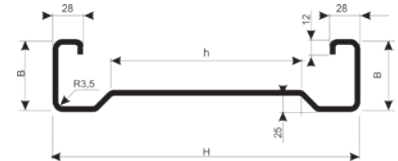
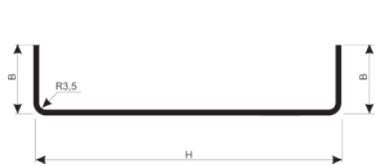

„U” profiles

	Sheet thickness mm	weight kg/m	H mm	B mm
U 100	1,50	2,57	100	60
	2,00	3,39	100	60
	2,50	4,20	100	60
	3,00	4,99	100	60
	3,50*	5,77	100	60
U 150	1,50	2,88	150	48
	2,00	3,81	150	48
	2,50	4,72	150	48
	3,00	5,62	150	48
	3,50*	6,50	150	48
U 150	1,50	3,17	150	60
	2,00	4,19	150	60
	2,50	5,20	150	60
	3,00	6,19	150	60
	3,50*	7,17	150	60
U 200	1,50	3,50	200	48
	2,00	4,64	200	48
	2,50	5,76	200	48
	3,00	6,86	200	48
	3,50*	7,95	200	48
U 250	1,50	4,51	250	65
	2,00	5,98	250	65
	2,50	7,44	250	65
	3,00	8,83	250	65
	3,50*	10,25	250	65
U 300	1,50	5,28	300	73
	2,00	7,04	300	74
	2,50	8,80	300	75
	3,00	10,56	300	76
	3,50*	12,32	300	77
U 350	1,50	5,66	350	64
	2,00	7,52	350	64
	2,50	9,36	350	64
	3,00	11,18	350	64
	3,50*	12,99	350	64
U 400	2,50	10,32	400	63
	3,00	12,34	400	63
	3,50*	14,34	400	63

„C+” profiles

	Sheet thickness mm	weight kg/m	H mm	B mm
C+ 200	1,50	4,80	200	69
	2,00	6,40	200	72
	2,50	8,00	200	75
C+ 250	1,50	5,64	250	79
	2,00	7,52	250	82
	2,50	9,32	250	83
C+ 300	2,50	10,32	300	83
C+ 350	2,50	11,32	350	83
C+ 400	2,50	11,68	400	67

„Σ+” profiles

	Sheet thickness mm	weight kg/m	H mm	L mm	B mm
Σ+ 200	1,50	5,04	200	90	70
	2,00	6,62	200	90	70
	2,50	8,20	200	90	71
Σ+ 230	1,50	5,64	230	120	80
	2,00	7,46	230	120	81
	2,50	8,80	230	120	71
Σ+ 260	2,50	9,32	260	150	70
Σ+ 300	2,50	10,32	300	190	74
Σ+ 350	2,50	11,32	350	240	74

Profiles Z, C, Σ

Σ, Z, C are manufactured from cold rolled steel. Their stiffness and strength parameters allow for wide application in load-bearing structures. Among most typical use of such profiles are the following:

- construction of casing and partition walls,
- laying of floor beams and eaves,
- wall beams,
- roof purlins.

These sections are the supplement to light development system and cladding for industrial, commercial and service facilities.

Openings

Z, C, Σ sections may have assembly openings (Ø 10 mm, Ø 12 mm, Ø 14 mm, Ø 16 mm, Ø 18 mm, Ø 22 mm, fasolka 14x18 mm, 14x25 mm, 19x25 mm). This makes their assembly with screws or rivets easier. Because of the possibility to disassemble the construction and its reuse, it is recommended to use screws.

Material

Galvanised steel tape (S350GD or S390GD) with magnelis coating ZM 120 in thickness from 1,5 to 3,5 mm. Due to use and needs, profiles don't need any additional protection, but they can be powder painted.

Dimensional tolerances of U, C+, Σ+ profiles

SYMBOL	DEVIATION FROM THE NOMINAL DIMENSION
B	± 2 mm
H	± 2 mm
h	± 2 mm

*Thickness 3,5 mm is available only for special orders, for more details please contact with our sale representatives. Details after consultation with the sales or technical department.

Elevation cassettes

Production process and quality control process assures the highest precision of workmanship, exact maintaining the dimension, which significantly influences precision and easy assembly. We use galvanised covered steel thickness from 1,20 mm up to 1,50 mm or aluminum steel thickness from 2,00 mm up to 3,00 mm for production. Also, our company offers elevation cassettes which can be covered with powder paint choosing one of the RAL palette colour. Fastening system offers quick and easy assembly without compromising durability and tightness of joints. Ask our Investment Department for specific information on customized development and assembly. Our staff is ready to provide assistance and comprehensive supervision of any project.

CLADDING CASSETTE KA-1 and CLADDING CASSETTE KS-1

Cross section through wall with light cladding

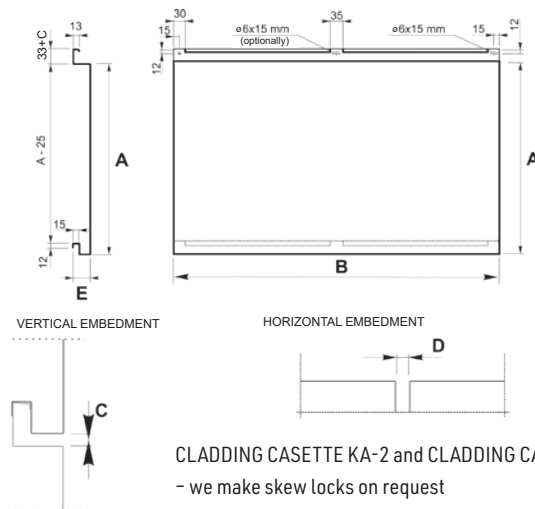
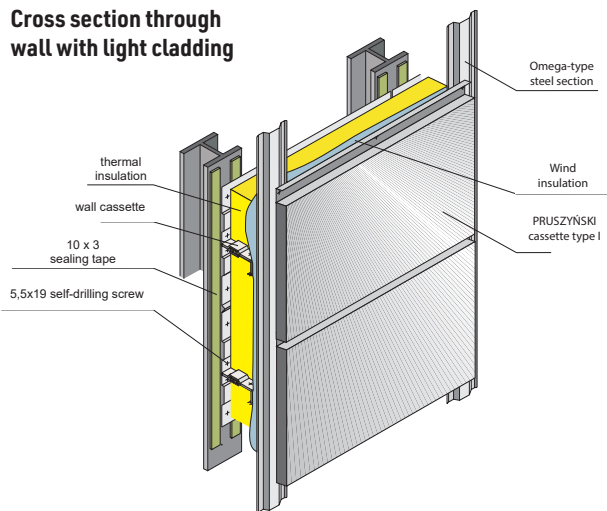

Sets of cassettes Pruszyński KA-1, KS-1, KA-2 and KS-2 for wall cladding received TOP BUILDER 2021 award

Dimension way	A		B		C		D		E	
	cover width		cover length		Width of joining in horizontal direction		Width of joining in vertical direction		Cassette thickness	
thickness/material	min	max	min	max	min	max	min	max	min	max
steel										
1,20	120	800	200	2800	0	30	acc. to design		30	60
1,25	120	800	200	2800	0	30	acc. to design		30	60
1,50	120	1000	200	2800	0	30	acc. to design		35	60
aluminium										
2,00	120	600	200	2400	0	50	acc. to design		35	60
2,50	120	800	200	2400	0	50	acc. to design		45	80
3,00	265	1000	200	2400	0	50	acc. to design		50	80



Cassette

New deeper wall cassettes is perfect material to quick wall constructions, especially of industrial halls/warehouses. Whole construction has now better stiffness and tightness.

Cassette is produced in 2 widths: 500 mm and 600 mm and range of height from 110 to 200 mm.

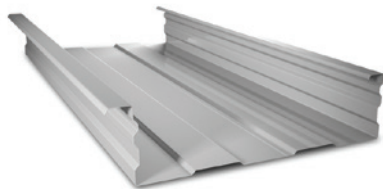

thickness - from 0.7 to 1.5 mm
colour - according to RAL
coating - galvanised, glossy polyester
length - minimum cassette length 1.5 m

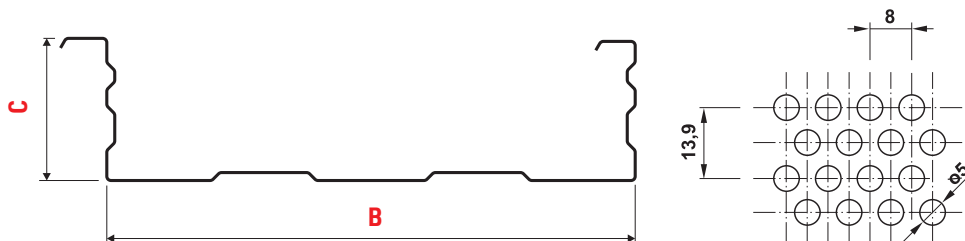

Type of perforation according to Pruszyński's standard

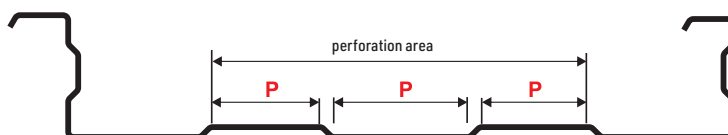

B - total width >> 500 mm
C - total height >> from 110 to 200 mm

Omega sections

OMEGA SECTION, PERFORATION

Cold-rolled omega type sections manufactured from galvanised tape. Our offer includes patches with three heights and thicknesses of core between 0.7 and 1.00 mm. Such range of dimensions allows for applying them in various types of construction.

Material

Double-sided hot-dipped galvanised steel, grade S280 GD or S350 GD.

Advantages

- high stiffness and strength;
- durability;
- small weight of structure;
- ideal plane of framing;
- convenient and easy assembly

Thickness - 0,7 - 1,00 mm
coating - organic
lengths - 0,5 to 6 lm

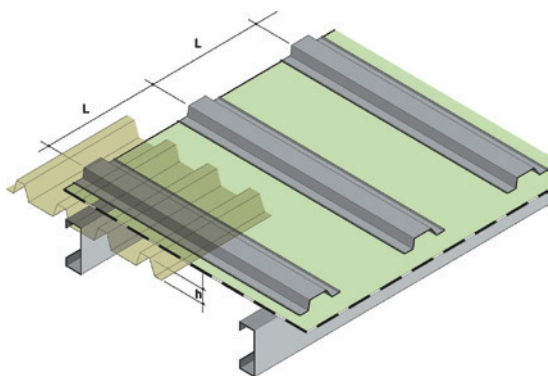

OMEGA 20 SECTION

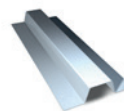

OMEGA 30 SECTION

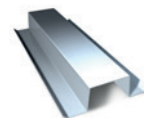
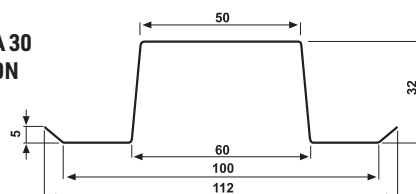

OMEGA 50 SECTION

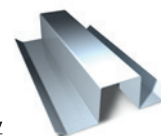
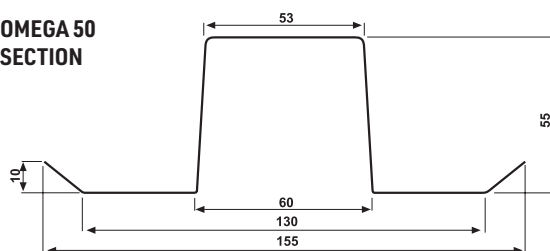

Possibility to manufacture in any other dimension up to 6 m in length

Perforation

In rich offer of Pruszyński's services there is also perforation of steel sheets. Perforated metal sheets work great as an element of the ventilation system (cover grills, fan housing), in sound-absorbing housing of industrial halls, as a decorative element on facades, balustrades and fences, in lighting (perfectly diffuses light), etc.

After perforation: the sheets are straightened and cut to size
Additional services: after perforation, sheets can be cut, bend, powder coated, etc.

Perforated sheets are made in accordance with PN 76 /M-94060/, DIN or in accordance with customer requirements.

Material: raw steel (black), galvanised, stainless, acid-resistant steel, aluminum, copper, brass, bronze and others.

Possible type of holes:

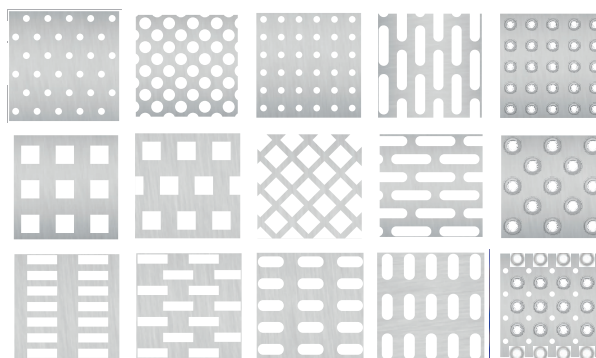

Tape width up to 1500 mm,
Sheet thickness up to 1,5 mm,
Opening diameter:

- Ø 3,2 mm
- Ø 4,0 mm
- Ø 5,0 mm

Distribution of perforations for selected trapezoidal profiles is presented below. It is possible to make perforations tailored to customer requirements.

Example of possible perforation T60

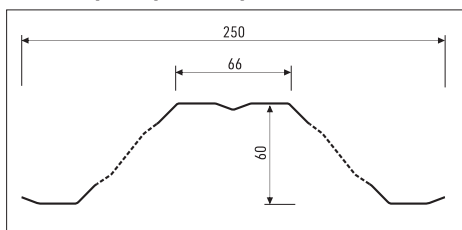

Example of possible perforation T20

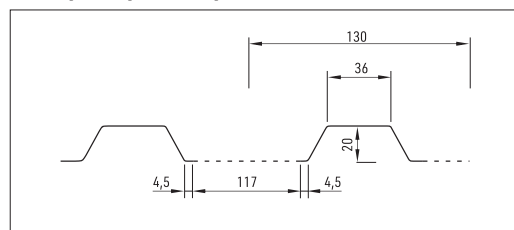

Example of possible perforation T92P

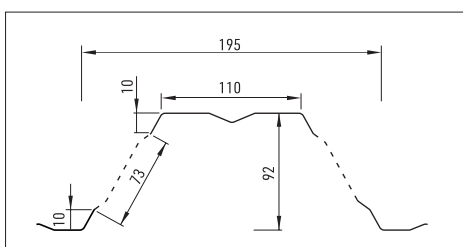

Example of possible perforation T135P

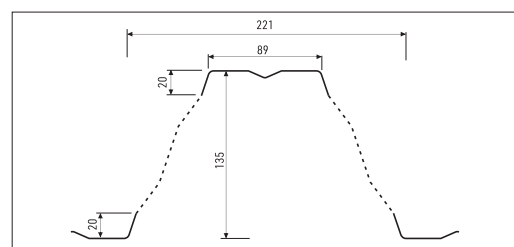

		FARM	FOOD SAFE
Properties		<ul style="list-style-type: none"> • Very good chemical resistance • Good corrosion resistance • Good formability • Thermosetting paint • Surface treatment and paint: free of hexavalent chromium and heavy metals 	<ul style="list-style-type: none"> • Very good UV resistance • Excellent corrosion resistance • Very good formability • Robust coating • Thermosetting paint • Surface treatment and paint: free of hexavalent chromium and heavy metals
Applications		Inner side of cladding, roofing (single sheets or sandwich panels), to be used in the aggressive environment of livestock and farm buildings	In cold storage rooms and food industry, for humid and aggressive conditions, with need to admission of safe temporary contact with food.
Description	Thickness	35 microns	120 microns
	Composition	Front (inner side of the building): 15 microns primer + 20 microns top coat Back (outer side of the building): Granite® HD, Granite® HDS, Granite® HDX for double-sided finish; 5 or 7 microns backing coat for sandwich panels	Front: 25 microns primer + 30 microns top coat Back: 10 or 12 microns backing coat Double-side finish available
	Gloss (Gardner 60°)	30 GU; Other gloss levels on request	30 GU; Other gloss levels on request
	Colours	Various shades of white	RAL 9010
	Appearance	Smooth	Grained
	Temporary protection (optional)	Self-adhesive film or heat-sealed film	Not applicable
Performance	Adhesion of the coating (T-bend)	≤ 1T	≤ 1T
	Resistance to cracking on bending (T-bend)	≤ 2T	≤ 1.5T
	Impact resistance	18 J	18 J
	Clemen scratch resistance	≥ 2 kg	≥ 3 kg
	Surface "pencil" hardness	HB To H	NOT APPLICABLE
	Corrosion resistance: • Salt spray test • Corrosion resistance category	360 hours	700 hours Rc5
	Condensation resistance: • QCT test • Corrosion protection (interior) category	1500 hours CPI4	1500 hours CPI4
	UV resistance: • QUV (UVA + H2O) test (2000 hours) • UV resistance category	NOT APPLICABLE	ΔE ≤ 2; GR ≥ 80 % RUV4
	Fire behaviour classification (EN 13501-1)	A1	A1 for colour class 1 to 4, A2 for metallic colour class 5
	Resistance to acids and bases	Good to very good	Good to very good
	Resistance to ammonia	Very good	Very good
	Resistance to solvents: • Aliphatics and alcohols • Ketones • Aromatics	Very good Very good Very good	Very good Low Good to very good
Resistance to mineral oils	Very good	Very good	
Automatic guarantee	<ul style="list-style-type: none"> • Non-perforation of the sheet metal • Non-delamination of the paint • Aesthetic appearance (ΔE ≤ 3; Gloss retention ≥ 80%) 	NOT APPLICABLE	15 years,
Remarks		These performance characteristics refer specifically to metallic coating Z275 (guaranteed minimum).	these performance characteristics refer specifically to metallic coating Z 275 (guaranteed minimum)

COLOURS

POLYESTHER COATINGS

glossy PS 25 µm

RAL 9010 ^{(1) (2) (3)} SNOWY WHITE	RAL 9002 ^{(1) (2)} WHITE	RAL 7035 ^{(1) (2)} GREY	RAL 9007 ^{(1) (2)} SILVER METALLIC	RAL 7000 ⁽¹⁾ GREY	RAL 7024 ⁽¹⁾ GRAPHITE	RAL 7016 ^{(1) (2)} ANTHRACITE	RAL 9006 ^{(1) (2) (3)} SILVER
RAL 5010 ^{(1) (2)} BLUE	RAL 6029 ^{(1) (2)} GREEN	RAL 6005 ⁽¹⁾ DARK GREEN	RAL 1021 ⁽¹⁾ YELLOW	RAL 1002 ^{(1) (2)} SAND	RAL 8004 ⁽¹⁾ BRICK	RAL 3016 ^{(1) (2)} CORAL	
RAL 3005 ⁽¹⁾ DARK CHERRY	RR 028 ⁽¹⁾ CHERRY	RAL 3011 ⁽²⁾ LIGHT CHERRY	RAL 8017 ^{(1) (2)} BROWN	RR 032 ⁽¹⁾ DARK BROWN	RAL 9005 ⁽¹⁾ BLACK	RAL 1015 ⁽¹⁾ CREAM - BEIGE	

10/30 Guarantee*
for years

The 25 µm layer of polyester varnish is an efficient protection against the destructive impact of UV radiation. The coating protects the steel against corrosion and ensures colour durability for years. Products with glossy polyester (PS) coating are granted even 30-year warranty.

PMG 35 µm coarse matt

RR 011 ⁽¹⁾ GREEN	RR 750 ⁽¹⁾ BRICK	RR 028 ⁽¹⁾ CHERRY	RR 032 ⁽¹⁾ DARK BROWN	RAL 8017 ⁽¹⁾ BROWN	RAL 7016 ⁽¹⁾ ANTHRACITE	RR 033 ⁽¹⁾ BLACK
--------------------------------	--------------------------------	---------------------------------	-------------------------------------	----------------------------------	---------------------------------------	--------------------------------

15/35 Guarantee*
for years

The coarse-grained PMG polyester coating is 35 µm of efficient protection against external factors. Used primarily for cut-to-size steel roof tiles, it creates a modern, matt finish for the building.

The same colors are available as ULTRAMATT - 35 µm thick matt polyester surface provided by Arcelor Mittal®.

TOPMAT

RR 750 ⁽¹⁾ BRICK	RAL 8017 ⁽¹⁾ BROWN	RAL 7016 ⁽¹⁾ ANTHRACITE	RR 033 ⁽¹⁾ BLACK	RAL 7042 ⁽¹⁾ LIGHT GREY
--------------------------------	----------------------------------	---------------------------------------	--------------------------------	---------------------------------------

20/35 Guarantee*
for years

TOPMAT® is a 35 µm thick matt polyester surface. It has 20% higher resistance to discoloration and higher corrosion resistance than glossy polyester coating. It's designed for panel roof tiles.

SPECIAL COLORS

RAL 8023 ⁽¹⁾ COPPER	(1) DARK WALNUT	(1) GOLDEN OAK
-----------------------------------	--------------------	-------------------

15/40 Guarantee*
for years

POLYURETHANE COATINGS

PURLAK

RAL 7016 ⁽¹⁾ ANTHRACITE	RAL 9005 ⁽¹⁾ BLACK
---------------------------------------	----------------------------------

PURMAT

RR 750 ⁽¹⁾ BRICK	RR 011 ⁽¹⁾ GREEN	RR 028 ⁽¹⁾ CHERRY
RAL 8017 ⁽¹⁾ BROWN	RR 033 ⁽¹⁾ BLACK	RAL 7016 ⁽¹⁾ ANTHRACITE

30/50 Guarantee*
for years

The polyurethane coverings PURLAK (gloss) and PURMAT (matt) are a 50-micron layer which effectively protects the cover against the harmful effects of sunlight. The risk of corrosion has been minimized, so that the coating can be used even in areas with a high degree of environmental aggressiveness.

(1) steel sheet thickness 0.5 mm, (2) steel sheet thickness 0.7 mm, (3) steel sheet thickness 1.0 mm,

Actual colours may vary from displayed or printed images. The shades of the coatings may vary depending on the coil of steel which the product is made of. If the customer requires a specific shade of coating color, please inform the sales person when placing the order.

*The guarantee period depends on the type of guarantee (aesthetic or technical). Check the conditions on the website pruszynski.com.pl or ask at the point of sale.



Pruszyński Sp. z o. o.
registered at The District Court
for the Capital City of Warsaw in Warsaw,
13th Commercial Division of the National Court Register
under the number 0000054020,
Share capital: PLN 17,635,000,
Tax Id: NIP 534-21-39-235, REGON 016480890

PRODUCTION PLANT

05-806 Komorów, Sokołów
ul. Sokołowska 32B
tel. 22 738 60 00, fax 22 738 61 01
www.pruszynski.com.pl
e-mail: pruszynski@pruszynski.com.pl



Concerns steel rooftiles, trapezoidal profiles, sandwich panels PIRTECH, WOOLTECH, roof panels, wall cassettes, corrugated profile, steel profiles and roof windows.



PRODUKT Z ATESTEM
certificate number: B.BK.60111.0034.2025
expiration date: 28.02.2030

Concerns steel rooftiles, coated metal sheets, trapezoidal profiles, roof and elevation panels, wall cassettes, elevation cassettes, corrugated profiles, steel profiles and typical sheet metal processes.



Concerns elevation cassettes.



Environmental Product Declaration Type III concerns sandwichpanels PIRTECH, sandwichpanels WOOLTECH, wall cassettes, trapezoidal profiles (except T84 and T94) and steel rooftiles: FIORD, REN, LOARA, KARO, REGLE, MODUS, OPTIMA, RUBIN, SZAFIR.

In connection with the offer updating and possible technological changes, PRUSZYŃSKI Sp. z o. o. reserves itself the right to introduce changes to this catalogue without prior notice. This catalogue is not an offer within the meaning of the Commercial Code.
2025.02



**Follow us on
FACEBOOK!**